

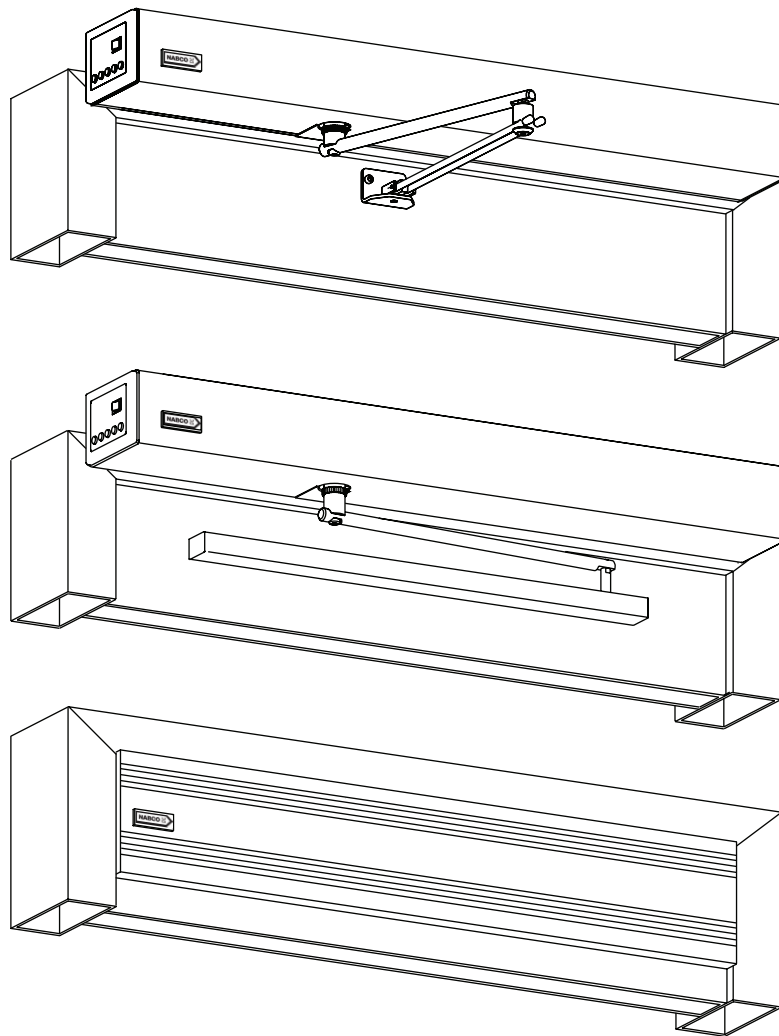

S82 W18717 Gemini Drive
Muskego, Wisconsin 53150
Phone: (877) 622-2694
Fax: (888) 679-3319
www.nabcoentrances.com
Technical Support: (866) 622-8325

GT20 Swing Door Operator Wiring and Programming Manual **With GT20 Control**



DN 1145

WARNING

- Turn OFF all power to the Automatic Door if a Safety System is not working.
- Instruct the Owner to keep all power turned OFF until corrective action can be achieved by a NABCO trained technician. Failure to follow these practices may result in serious consequences.
- NEVER leave a Door operating without all Safety detection systems operational.

Part #C-00140
Rev. 6/28/16

THIS PAGE IS INTENTIONALLY LEFT BLANK

Table of Contents

Warning Labels iii

General Safety Recommendations iii

CHAPTER 1: SCOPE **1-5**

 Section 1a: To the Installer 1-5

 Section 1b: Objective. 1-5

CHAPTER 2: 120 VAC GENERAL WIRING **2-6**

CHAPTER 3: THE POWER/PROGRAM SELECTOR **3-7**

 Section 3a: Power Switch 3-7

 Section 3b: Program Selector Buttons 3-7

CHAPTER 4: PROGRAMMING THE GT20 CONTROL **4-8**

CHAPTER 5: GENERAL WIRING **5-10**

 Section 5a: Activation Devices 5-10

 Section 5b: Safety Devices (Optional) 5-11

 Section 5c: Safety with Monitoring Function 5-12

 Section 5d: Locking Devices 5-13

 Section 5e: Single Swing Door 5-14

 Section 5f: Double Swing Door: Master 5-15

 Section 5g: Double Swing Door: Slave 5-16

 Section 5h: Dual Pair/Simultaneous Pair: Side A 5-17

 Section 5i: Dual Pair/Simultaneous Pair: Side B 5-18

 Section 5j: Other 5-19

 Section 5k: Standard Wiring for Single Full-Automatic 5-20

 Section 5l: Standard Wiring for Sim Pair Full-Automatic 5-21

CHAPTER 6: INITIAL SETUP PROCEDURE **6-22**

 Section 6a: The Joystick. 6-22

 Section 6b: Setup Procedure. 6-22

 Section 6c: Reset Back to Factory Default 6-26

CHAPTER 7: PROGRAMMING **7-27**

 Section 7a: The Four Levels of Menu Navigation 7-27

 Section 7b: The Home Page 7-27

 Section 7c: Menu Selection. 7-28

CHAPTER 8: DOUBLE SWING DOORS 8-34

Section 8a: Activation Input Connections:8-34

Section 8b: Safety Element Connections:8-34

Section 8c: EMY-IN Sensor Connections:8-34

Section 8d: Electric Lock Connections:8-34

Section 8e: Open/Close Settings.8-35

Section 8f: Sensor Signals8-35

Section 8g: Emergency Stop8-36

Section 8h: Check Connections.8-36

Section 8i: Interlock Operation8-36

Section 8j: Check Connections8-37

CHAPTER 9: RELAY PRINT 9-38

Section 9a: Install the Relay PCB Board.9-38

Section 9b: Program the Relay PCB Board9-39

CHAPTER 10: TROUBLESHOOTING 10-41

Section 10a: Malfunction with Error - No 10-41

Section 10b: Malfunction without an Error Code 10-45

CHAPTER 11: SOFTWARE UPDATE VIA USB 11-47

Section 11a: Preparation 11-47

Section 11b: Procedure 11-47

WARNING LABELS

Warning labels are universal and used to alert an individual of potential harm to one's self or to others. The following warning labels are listed in a hierarchy order that defines the most potential danger first, and the least potential danger last. Please refer to this page in the event that a warning label is displayed within this manual and further definition needs to be explained.

DANGER

Indicates potentially dangerous situations. Danger is used when there is a hazardous situation where there is a *high* probability of severe injury or death. It should not be considered for property damage unless personal injury risk is present.

WARNING

Indicates a hazardous situation which has *some* probability of severe injury. It should not be considered for property damage unless personal injury risk is present.

CAUTION

Indicates a hazardous situation which *may result in a minor injury*. Caution should not be used when there is a possibility of serious injury. Caution should not be considered for property damage accidents unless a personal injury risk is present.

Attention: A situation where material could be damaged or the function impaired.

Notice: Indicates a statement of company policy as the message relates to the personal safety or protection of property. Notice should not be used when there is a hazardous situation or personal risk.

Note: Indicates important information that provides further instruction.

GENERAL SAFETY RECOMMENDATIONS

DANGER

According UL 325 8.4, Do Not mount Operator onto flammable surfaces!

WARNING

Read this "General Safety Recommendations" section before installing, operating or servicing the automatic door. Failure to follow these practices may result in serious consequences. If you do not understand the instruction, ask the installing qualified technician to teach you how to use the door.

WARNING

Do not install, operate or service this product unless you have read and understand the General Safety Recommendations, Warning Labels, Installation and Operating Instructions contained in this manual. Failure to do so may result in bodily injury, or property damage.

WARNING

If the door appears broken or does not seem to work correctly, it should be immediately removed from service until repairs can be carried out or a qualified service technician is contacted for corrective action.

WARNING

The GT20 Swing Door Operator Assembly must not be mounted within locations presenting explosion hazards. The presence of flammable gases or smoke represents a considerable safety hazard.

Attention: Any modifications of the installation that are not described in this manual are not approved by the manufacturer.

Notice: This manual and the owner's manual must be given to and retained by the purchasing facility or end user.

- ▶ When configuring the installation, it is essential to make sure local regulations are complied. It is particularly important to ensure Door Panels do not have any sharp edges. The secondary closing edges must be designed by customers in such a fashion as to eliminate any dangerous crushing and shearing points.
- ▶ Application limits must be observed.
- ▶ Choice of Fasteners depend on the construction base.
- ▶ The swing door drive mechanism GT20 may only be installed and operated for indoor use. If this condition cannot be fulfilled, the customer must provide sufficient protection from moisture.
- ▶ In order to guarantee the safety of the users at all times, the installation must have an AAADM inspection before it is put into service and during normal operation, at least once a year.
- ▶ It is inadmissible to bypass, shunt or disable the safety devices. Any defective safety devices may not be disconnected in order to continue the operation of the installation.
- ▶ Disconnect power at the branch circuit protection during all electrical or mechanical service. When uncertain whether power supply is disconnected, always verify using a voltmeter.
- ▶ All electrical troubleshooting or service must be performed by qualified electrical technicians and must comply with all applicable governing agency codes.
- ▶ It is the responsibility of the installing door technician to install all warning and instructional labels in accordance with ANSI 156.10 (Full Energy) or ANSI 156.19 (Low Energy) and verify compliance.
- ▶ It is the responsibility of the purchasing facility or end user to keep warning and instructional labels and literature legible, intact and with the door.
- ▶ Replacement labels and literature may be obtained from local NABCO Entrances, Inc. distributors. If the name of the local distributor is unknown, contact NABCO Entrances, Inc. at 1-877-622-2694 for assistance.
- ▶ A safe and reliable function of the installation can only be guaranteed if it is operated with the original NABCO Entrances, Inc. accessories/spare parts. NABCO Entrances, Inc. declines all responsibility for damages resulting from unauthorized modifications of the installation or from the use of foreign accessories/spare parts.

DANGER

Do not place finger or uninsulated tools inside the electrical controller. Touching wires or other parts inside the enclosure may cause electrical shock, serious injury or death.

DANGER

According UL 325 8.4, Do Not mount Operator onto flammable surfaces!

CHAPTER 1: SCOPE

Section 1a: To the Installer

The purpose of this manual is to familiarize the installer and purchaser with the proper installation and operation of this system. It is essential that this equipment be properly installed and operational before the door is used by the public. It is the installer's responsibility to inspect the operation of the entrance system to be sure it complies with any applicable standards. In the United States, ANSI Standard 156.10 (Full Power) and ANSI Standard 156.19 (Low Energy) covers the GT20 Swing Door Operator Assembly. Other local standards or codes may apply. Use them in addition to the ANSI standard. Both Full Power and Low Energy Swing door Units are listed by UL according to UL325 and is identified as such on the label.

Instruct the building owners and operator on the essentials of the operation of this device. The owner should follow these instructions to determine whether the door is operating properly and should immediately call for service if there is any malfunction. All installation changes and adjustments must be made by qualified, NABCO trained technicians.

Replacement labels and literature may be obtained from local NABCO Entrances, Inc. Distributors. If the name of the local distributor is unknown, contact NABCO Entrances, Inc. at 1-877-622-2694 for assistance.

Section 1b: Objective

The Swing Door Operator assembly is designed to be installed onto the top surface of the Door Frame, or Door Panel, or between the Jamb Tubes under the Door Frame (OHC). This manual was created to offer step by step instructions.

CHAPTER 2: 120 VAC GENERAL WIRING

DANGER

Shut the installation site, branch Circuit Breaker OFF. Failure to do so may result in serious personal or fatal injury. When uncertain whether power supply is disconnected, always verify using a voltmeter.

WARNING

All high voltage electrical connections must be made by licensed electricians according to National and Local electrical codes/regulations.

CAUTION

Permanent wiring shall be employed as required by local codes.

CAUTION

Keep all Incoming 120 VAC wiring separate from low voltage wiring within Header. 120 VAC Power wires must be routed (separate from other wiring) located near the top of inside Header.

CAUTION

Ensure that the Grounding of the Electric Power Supply is installed/connected in a proper way (especially the PE Cable from the Building Side).

Attention: Depending upon the installation, the Power Switch/Program Selector may have to be installed on the opposite side of the Header. If 120 VAC Power wires must be installed from Hinge Side of Header, ensure all wires are securely clipped to prevent pinching of the wires during the Motor/Operator installation process.

Note: Please see "The Motor Connector Harness" chapter within this manual for wiring details.

1. Connect the Main Power Supply. Please see Figure 2-1.
2. Mount the Side Cover.

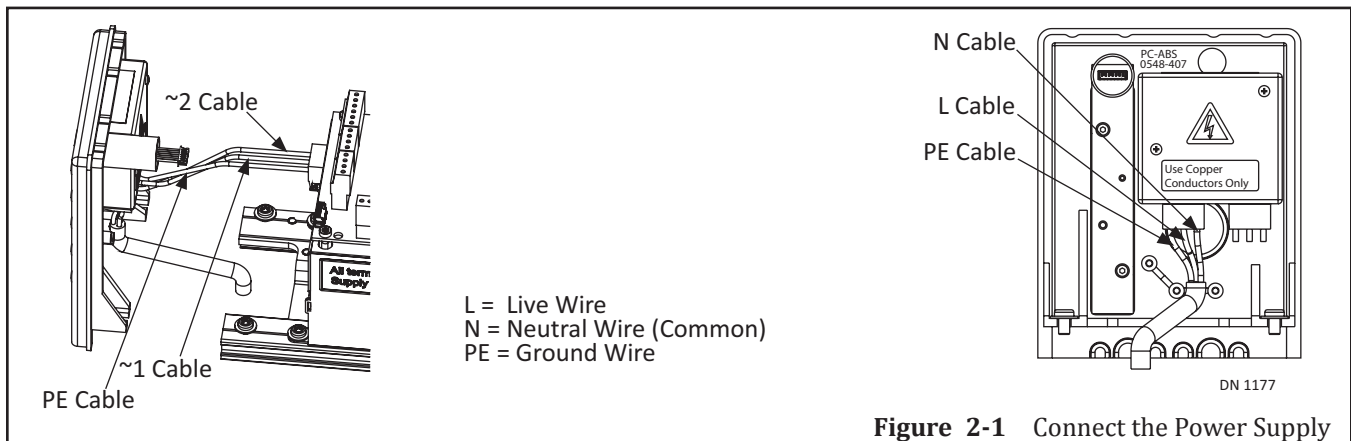

CHAPTER 3: THE POWER/PROGRAM SELECTOR

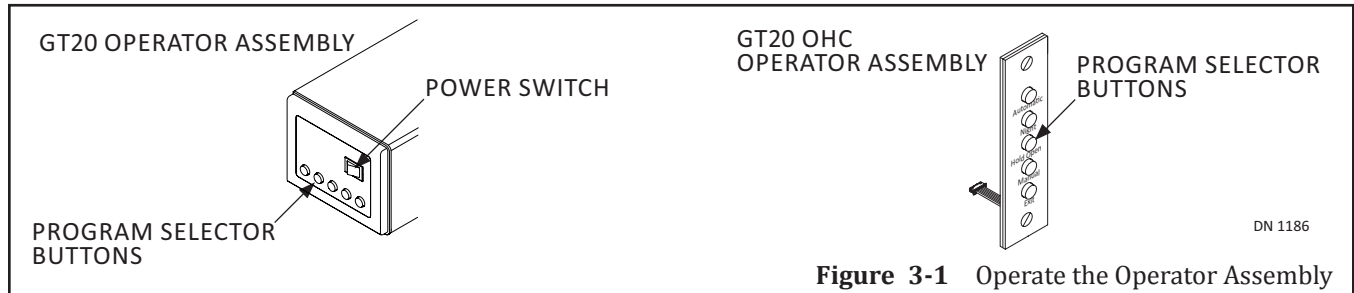

Figure 3-1 Operate the Operator Assembly

Note: Depending upon the installation, the Power/Program Selector Switch may have to be installed on the opposite side of the Header.







Section 3a: Power Switch

The Power Switch is utilized to turn ON/OFF the power supply to the Operator Assembly.

Section 3b: Program Selector Buttons

By pressing the appropriate LED Button, the Program Selector is utilized to activate Operating Modes. Each LED Button is identified by an Icon. Please see Figure 3-1.

Table 3-1 Operating Modes

Automatic 	<ul style="list-style-type: none"> ▶ Door Panel is opened by an Activation Device or a Knowing Act. ▶ Door Panel is closed upon expiration of the adjustable hold-open time.
Night 	Door Panel can only be opened by an Activation Device connected to a Key Terminal (Example: an exterior card reader).
Open 	Door Panel will fully open and remain in the Full Open position.
Manual 	All activation devices are ignored, Door Panel must be opened manually. An Internal Spring is utilized to: <ul style="list-style-type: none"> ▶ Close the Door Panel for Standard Applications. ▶ Open the Door Panel for Inverse Applications (unless the Door Panel has not been locked).
Exit 	One Way: The Door Panel is opened by an <i>Interior Activation Device</i> only.
SET-UP PROCEDURE (TEACH) 	Completely close the Door Panel (Invers = open). Hold the Buttons MANUAL and EXIT simultaneously at least 5 seconds. All pending errors will be deleted and a set-up procedure (Teach) is carried out.
All LED Buttons will flash in the event of a pending fatal error.	

CHAPTER 4: PROGRAMMING THE GT20 CONTROL

DANGER

Do not place finger or uninsulated tools inside the electrical GT20 Control. Touching wires or other parts inside the enclosure may cause electrical shock, serious injury or death.

DANGER

Shut Breaker OFF. Failure to do so may result in serious personal or fatal injury. When uncertain whether power supply is disconnected, always verify using a voltmeter.

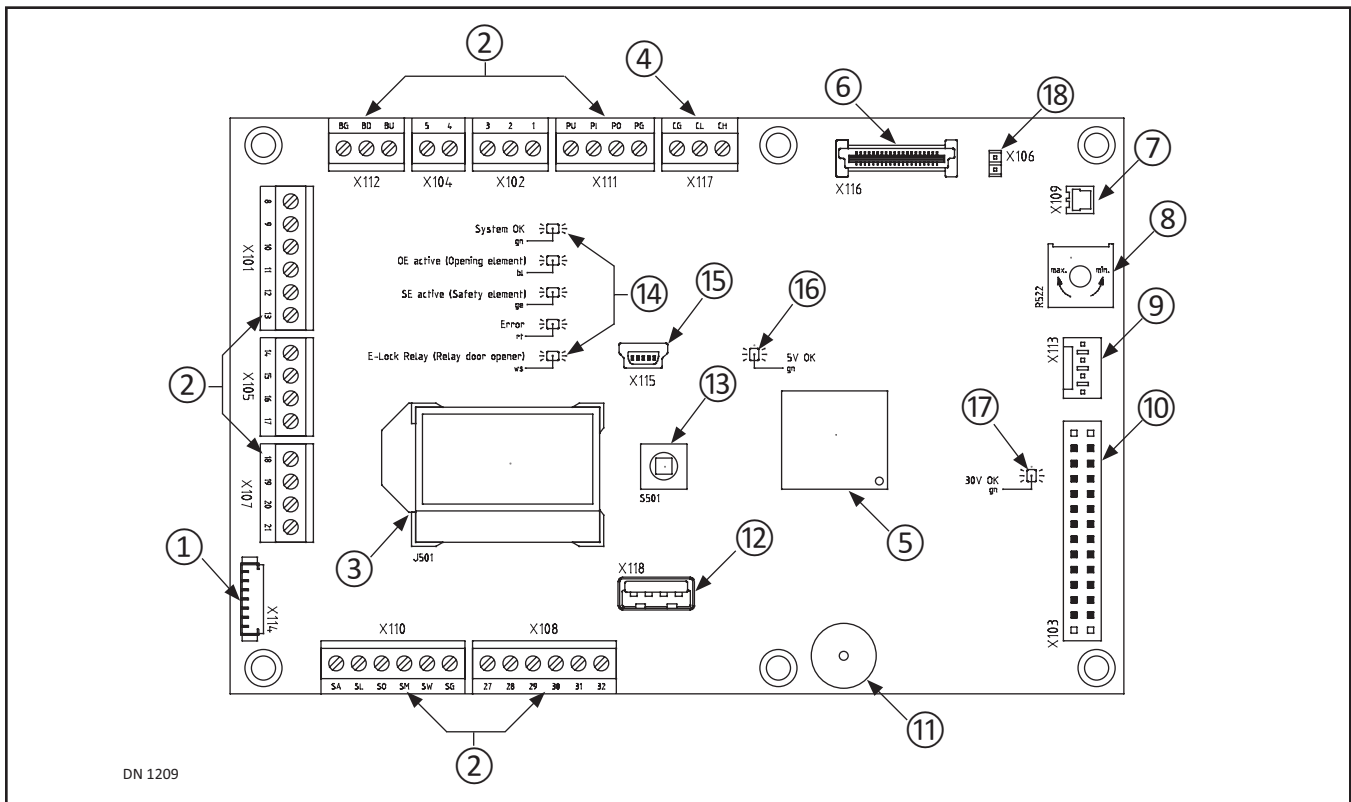

DN 1209

Table 4-1

Terminals (1-13)					
#	Description	#	Description	#	Description
1	Power/Program Selector Switch	7	Reference Switch Connection	13	Joystick
2	Connection Terminals	8	Potentiometer (FSlam)	14	LEDs
3	LCD Display	9	Connection to Encoder	15	Serial Port
4	CAN Bus Port	10	Connection to Power Supply	16	Status LED = green
5	Processor	11	Buzzer	17	Status LED = green
6	Relay PCB Board (available March 2016)	12	USB Port	18	Jumper

Table 4-2

LEDs (14)		
LED	Description	Indicator
SOK	System OK	green flashing
OE active	Opening Element	blue = activ
SE active	Safety Element	yellow = activ
ERROR	ERROR	red
E-Lock Relay	E-Lock Relay	white

Table 4-3 Terminal Connections

Terminal Connections			
Terminal	Description	Connector	Description
X101	Opening Command Outside	8	24 VDC
		9	OEO
		10	GND
X101	Opening Command Inside	11	24 VDC
		12	OEI
		13	GND
X102	Key Operated Switch	1	24 VDC
		2	KEY
		3	GND
X103	Plug-In connection to the Power Supply Unit	N/A	N/A
X104	Emergency Close/Open/Stop	4	EmA
		5	EmB
X105	Safety Element Stop	14	SE 24V
		15	SE Stop
		16	SE Test
		17	GND
X106	Jumper	N/A	N/A
X107	Safety Element Reverse	18	SE 24V
		19	SE Rev
		20	SE Test
		21	GND
X108	Motor or Electric Lock	27	EL 24V
		28	GND
		29	EL-COM
		30	EL-NO
		31	EL-NC
		32	EL-Fb
X110	External Program Selector	SA	Auto
		SL	Locked
		SO	Open
		SM	Manual
		SW	One Way
		SG	GND
X111	Present Sensor Sensor is only checked before the door moves	PU	Programmable I/O Voltage
		PI	Programmable Input
		PO	Programmable Output
		PG	GND
X113	Connection to the Encoder	N/A	N/A
X114	Power/Program Selector Switch	N/A	N/A
X115	Serial Port	N/A	N/A
X116	Connection to the Relay PCB Board (Available March 2016)	N/A	N/A
X117	Can Bus	CG	GND
		CL	CAN Low
		CH	CAN High
X118	USB/Service	N/A	N/A

CHAPTER 5: GENERAL WIRING

WARNING

Route the wiring away from moving parts or sharp edges likely to cause damage to this wiring.

WARNING

Any external switches has to be installed in a location from which operation of the Door can be observed by the person operating the switch.

CAUTION

Appliance must be disconnected from the source of supply before attempting the installation of accessories.

Section 5a: Activation Devices

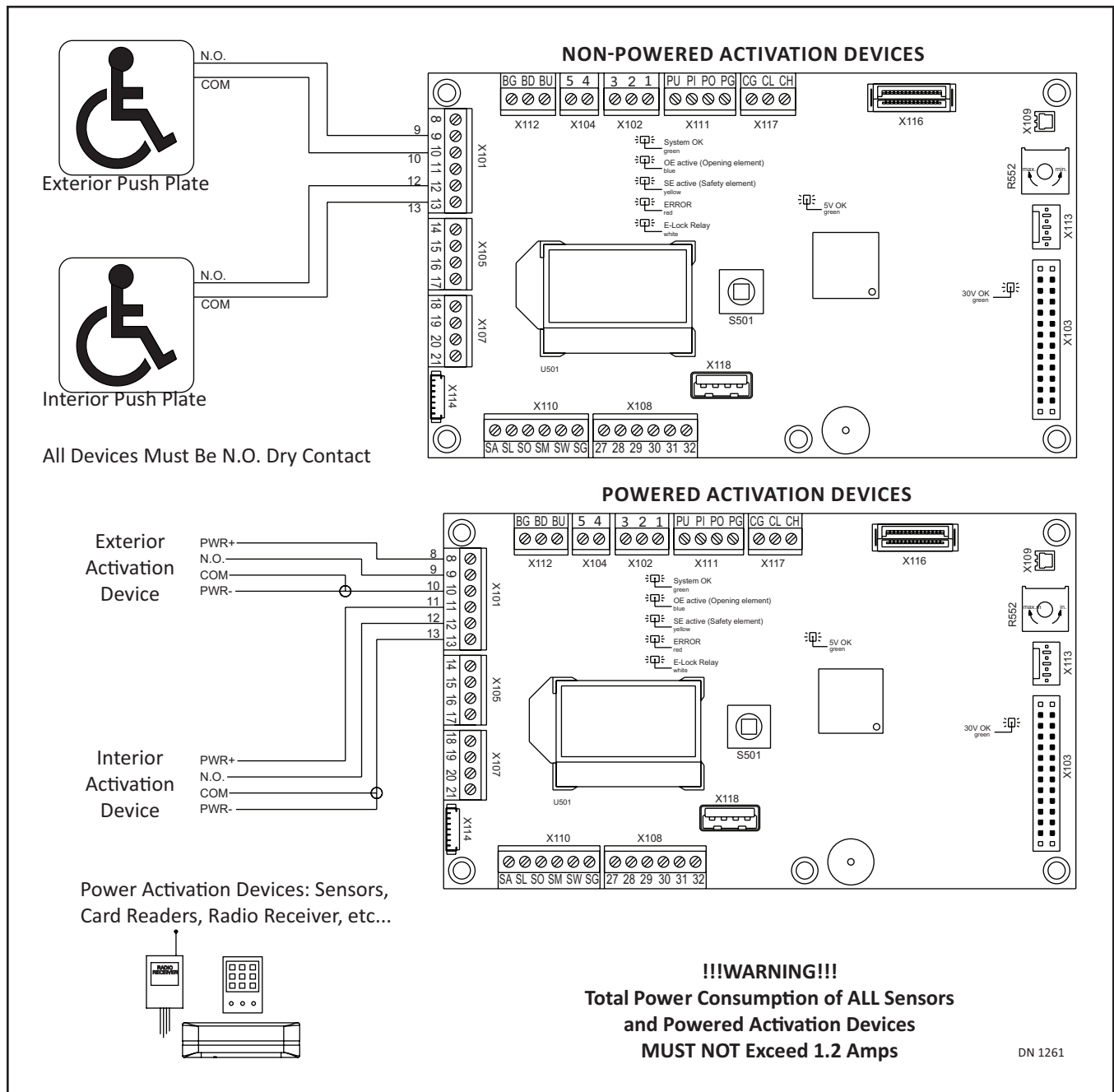

Section 5b: Safety Devices (Optional)

All Safety Sensors Must Use Normally Closed Contacts

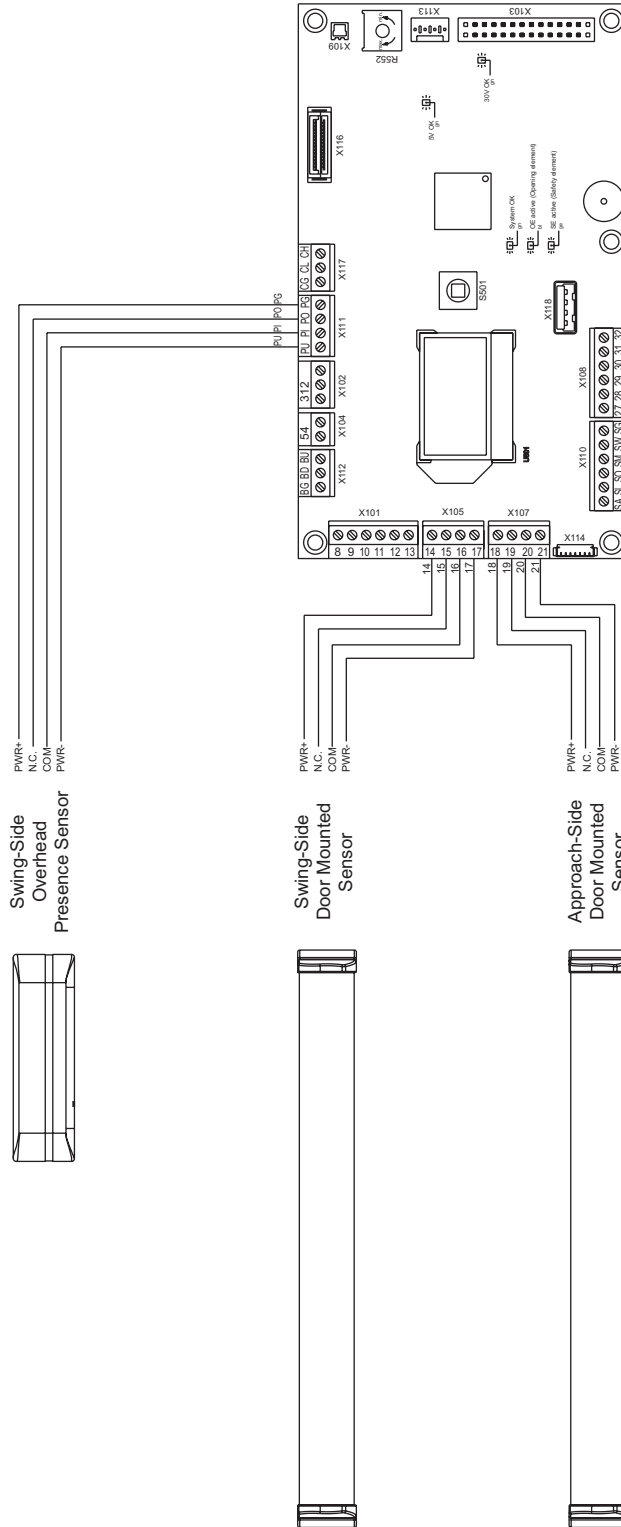

WARNING!
 When Any Safety Sensor Input is not Used,
 A Jumper Must Be In Place At Input Terminals
 15 ↔ 16, and 19 ↔ 20.

WARNING!
 Total Power Consumption Of All Sensors And Powered Activation
 Devices Must Not Exceed 1.2 Amps.

DN 1.262

Section 5c: Safety with Monitoring Function

**All Safety Sensors Must Use
Normally Closed Contacts**

Swing-Side
Overhead
Presence Sensor



PWR+
N.C.
COM-
PWR-

Swing-Side
Door Mounted
Sensor



PWR+
N.C.
COM-
PWR-

Approach-Side
Door Mounted
Sensor



PWR+
N.C.
COM-
PWR-

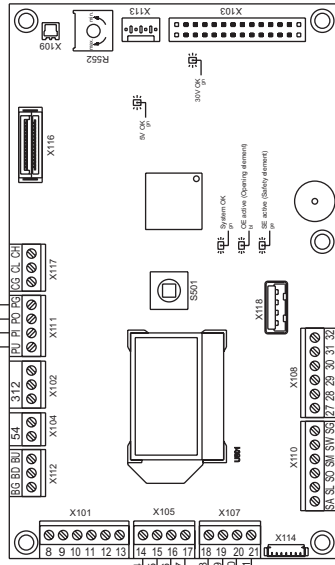

WARNING!
When Any Safety Sensor Input is not Used,
A Jumper Must Be In Place At Input Terminals
15 ↔ 16, and 19 ↔ 20.

WARNING!
Total Power Consumption Of All Sensors And Powered Activation
Devices Must Not Exceed 1.2 Amps.

DN 1262

Section 5d: Locking Devices

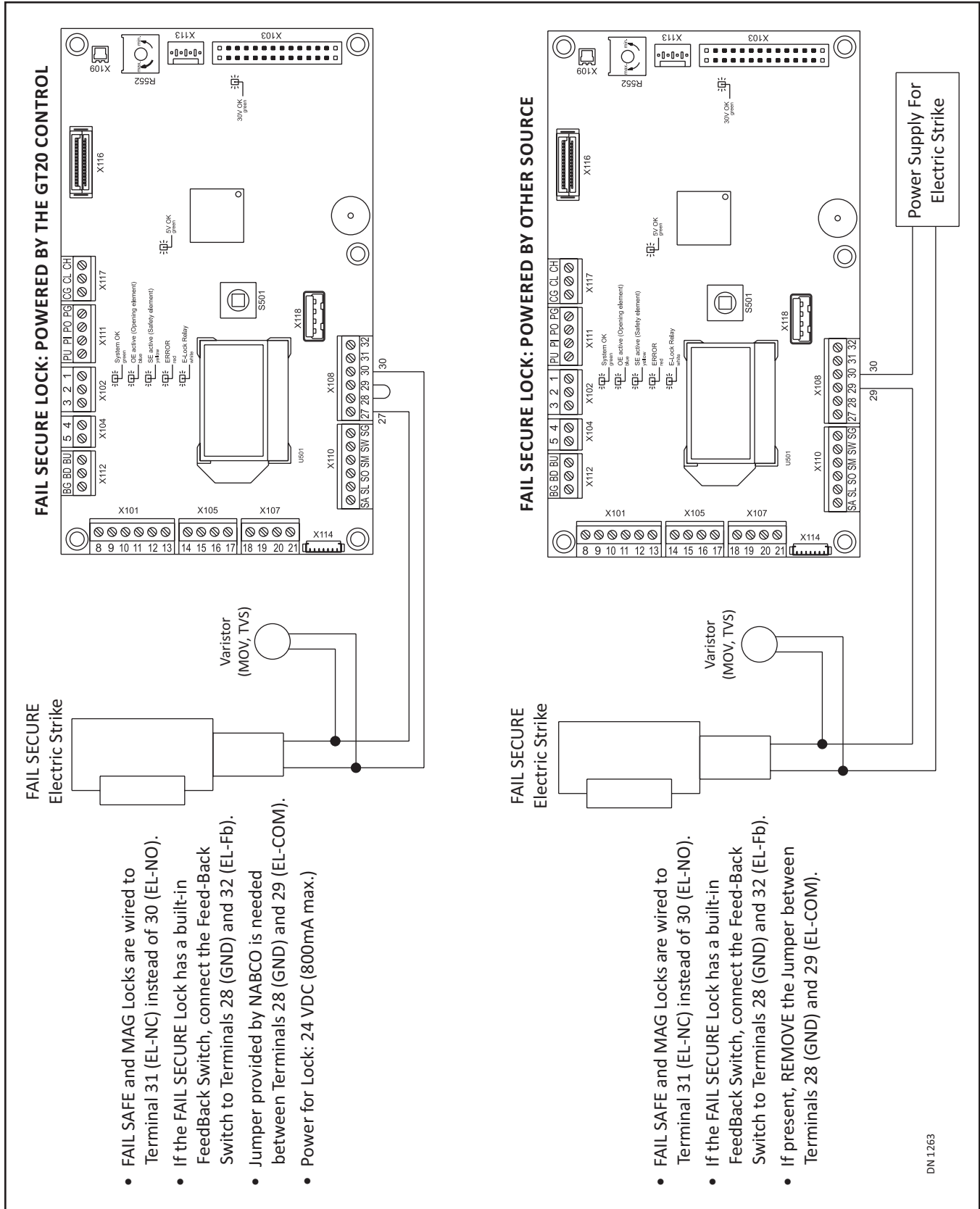

Section 5e: Single Swing Door

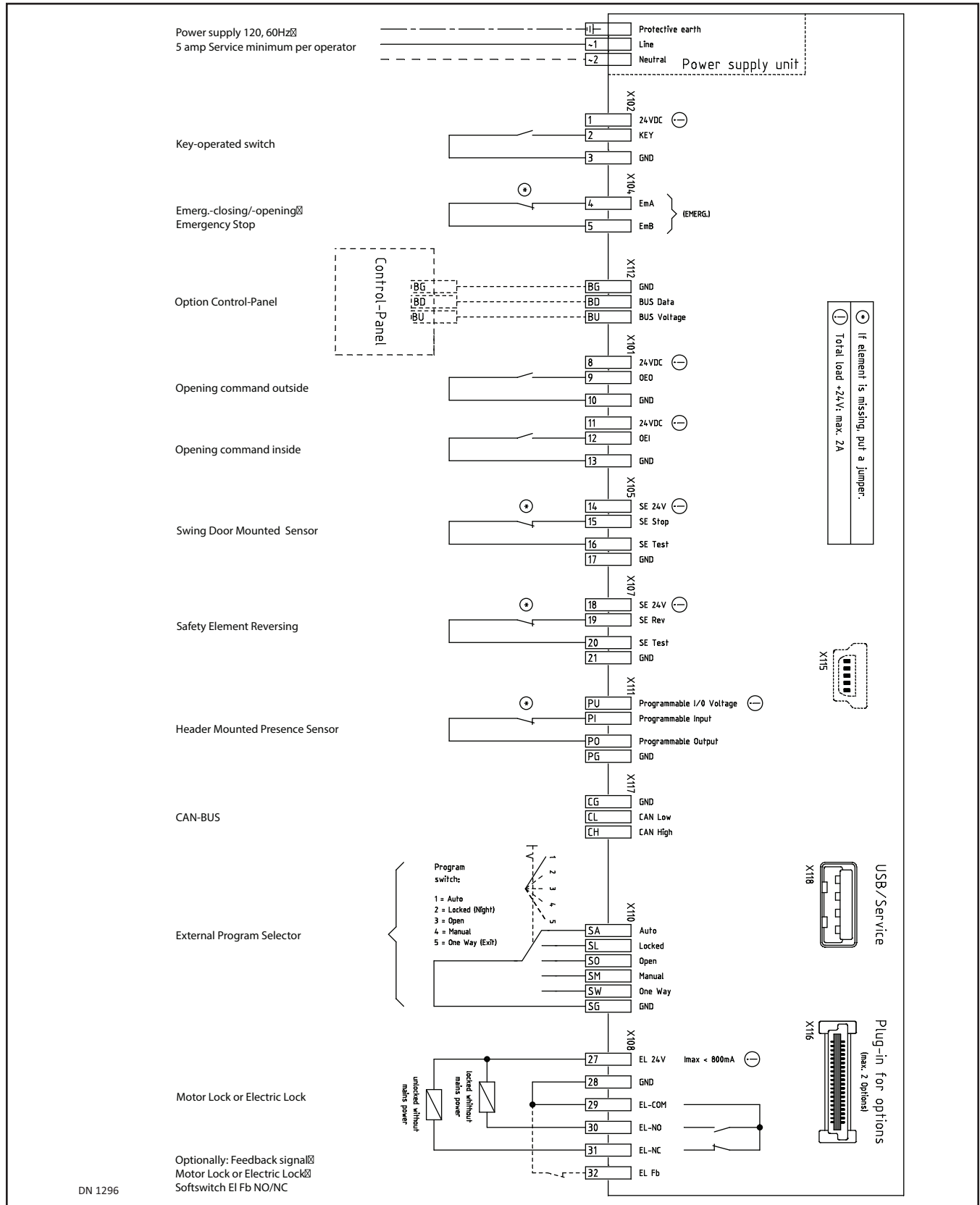

DN 1296

Section 5f: Double Swing Door: Master

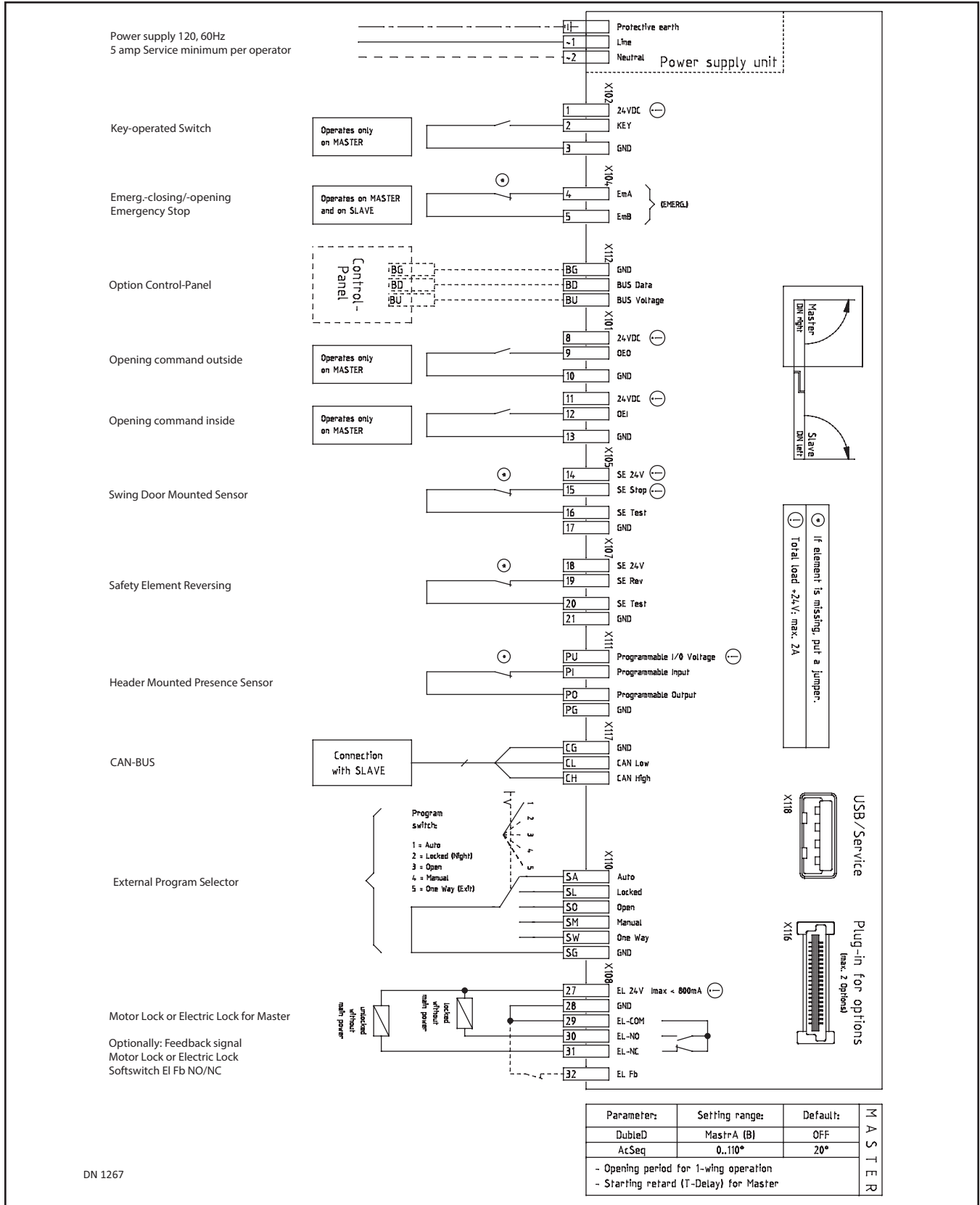

DN 1267

Section 5g: Double Swing Door: Slave

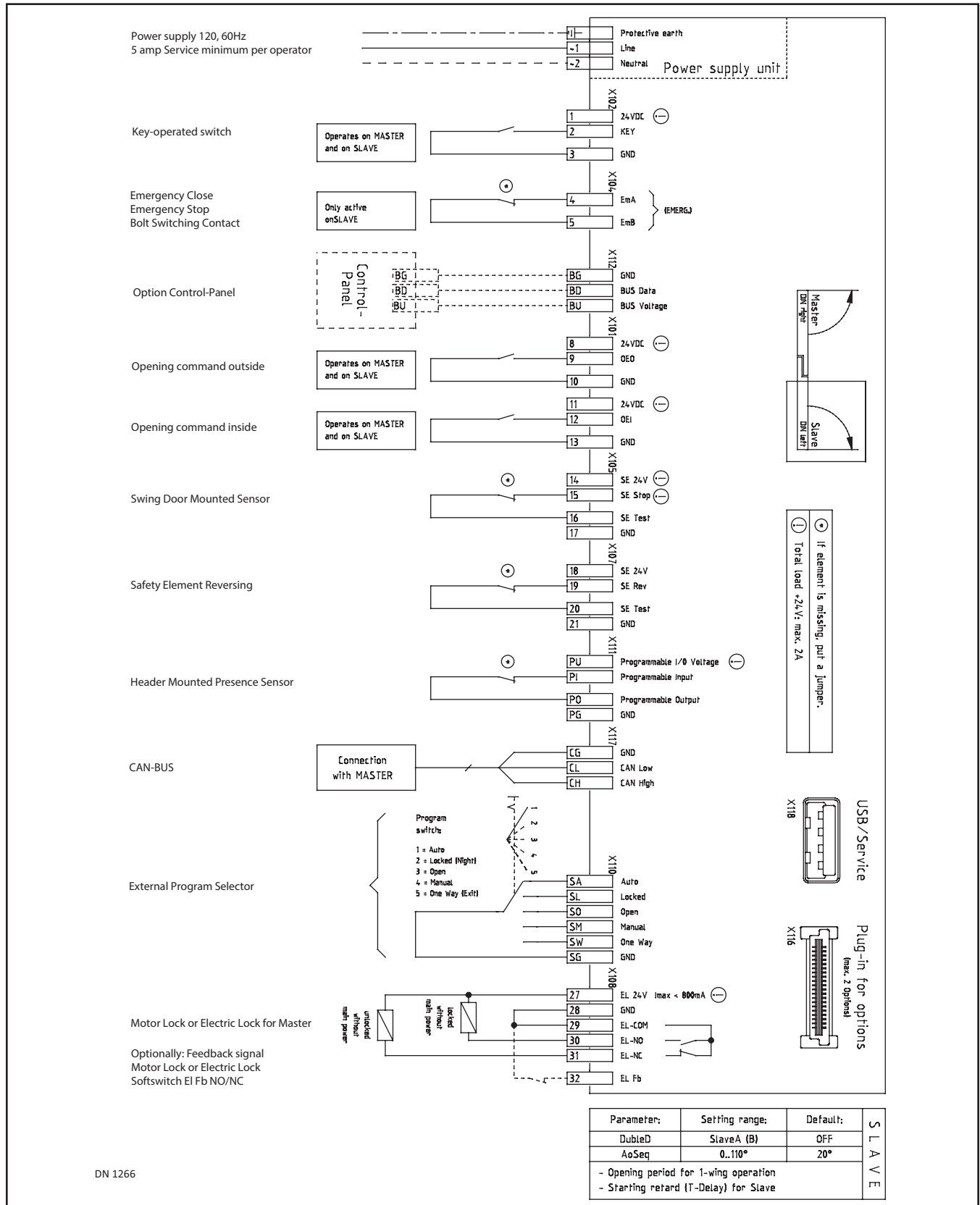

Section 5h: Dual Pair/Simultaneous Pair: Side A

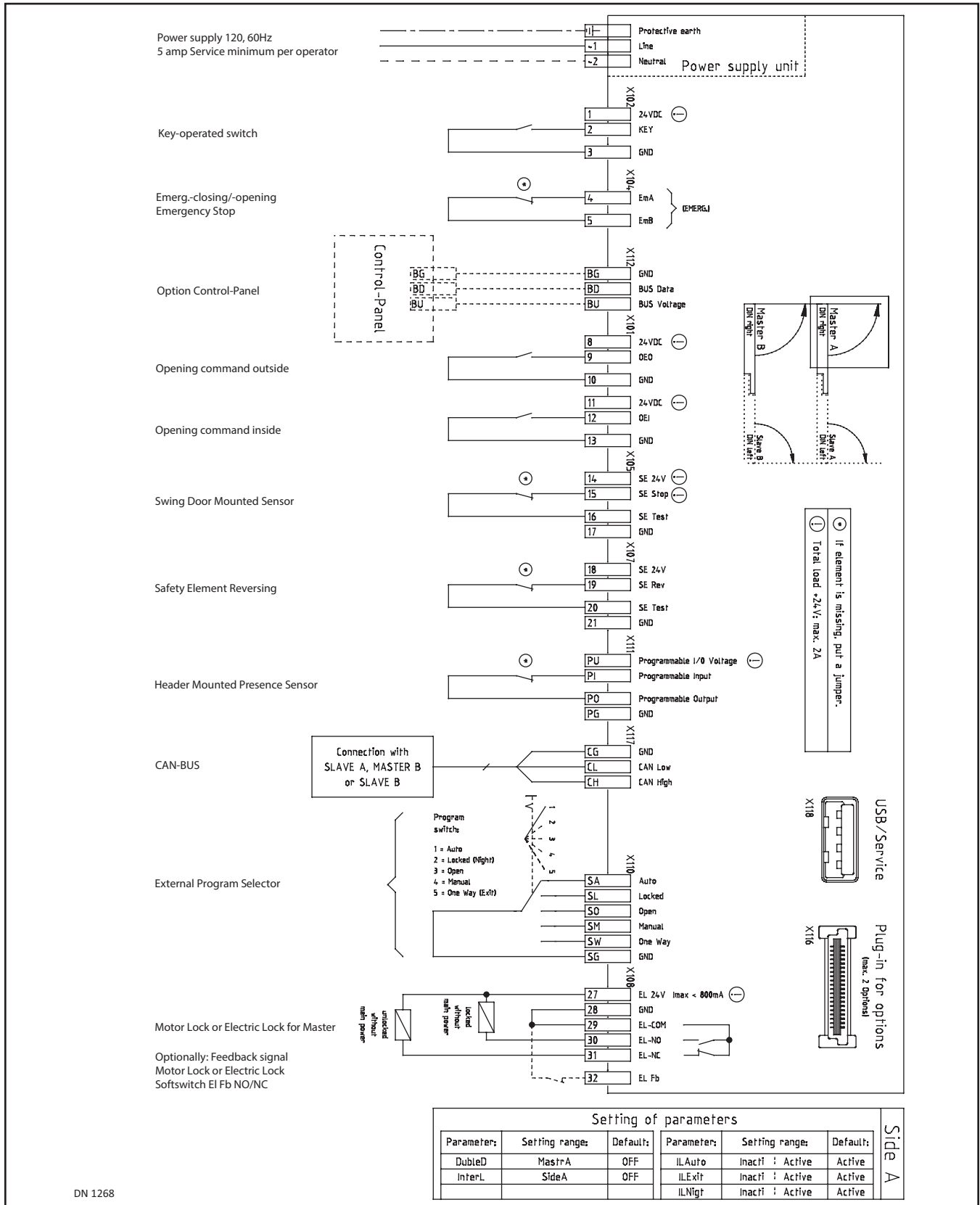

DN 1268

Section 5i: Dual Pair/Simultaneous Pair: Side B

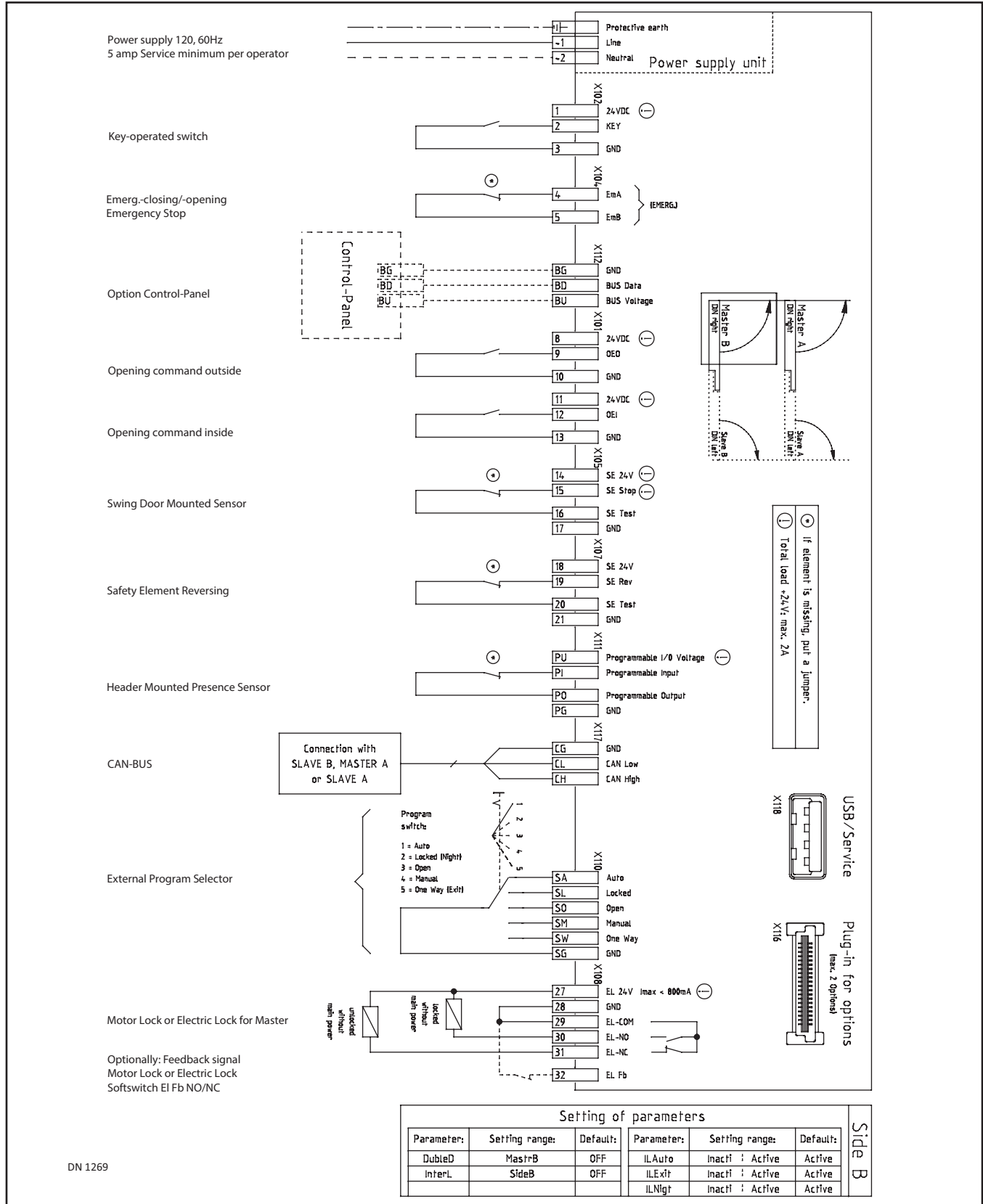

DN 1269

Section 5j: Other

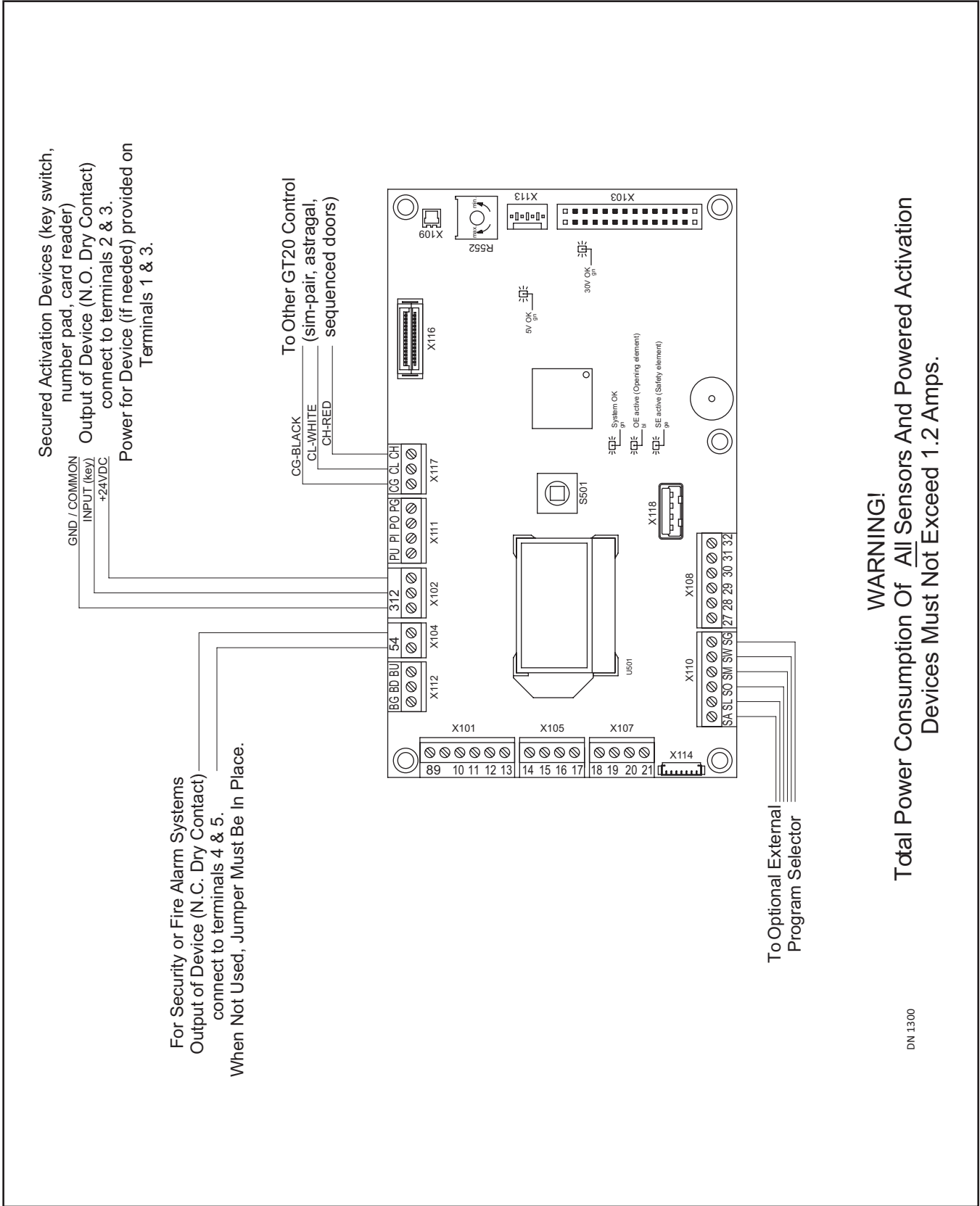

Section 5k: Standard Wiring for Single Full-Automatic

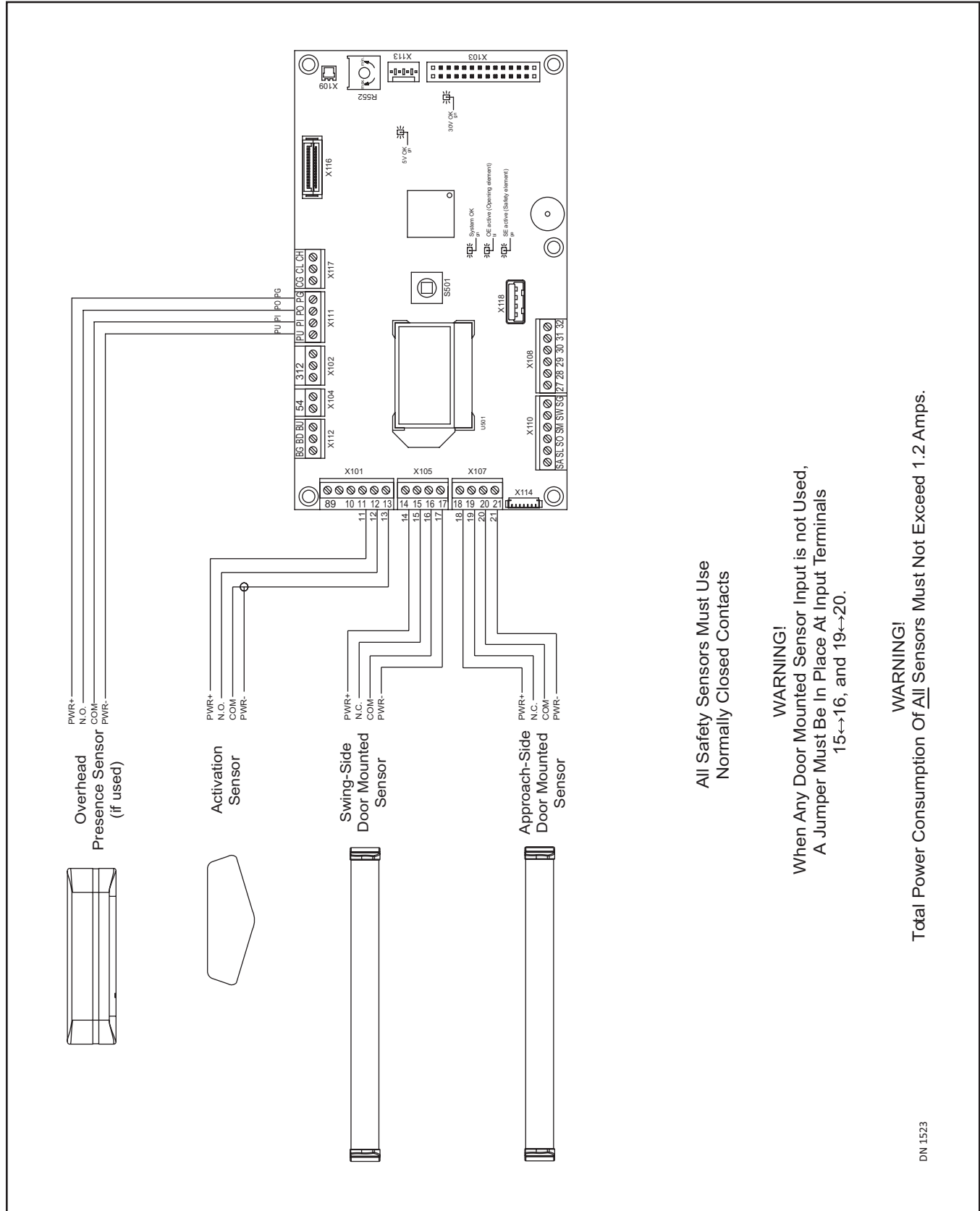

All Safety Sensors Must Use Normally Closed Contacts

WARNING!
 When Any Door Mounted Sensor Input is not Used, A Jumper Must Be In Place At Input Terminals 15↔16, and 19↔20.

WARNING!
 Total Power Consumption Of All Sensors Must Not Exceed 1.2 Amps.

DN 1523

Section 5I: Standard Wiring for Sim Pair Full-Automatic

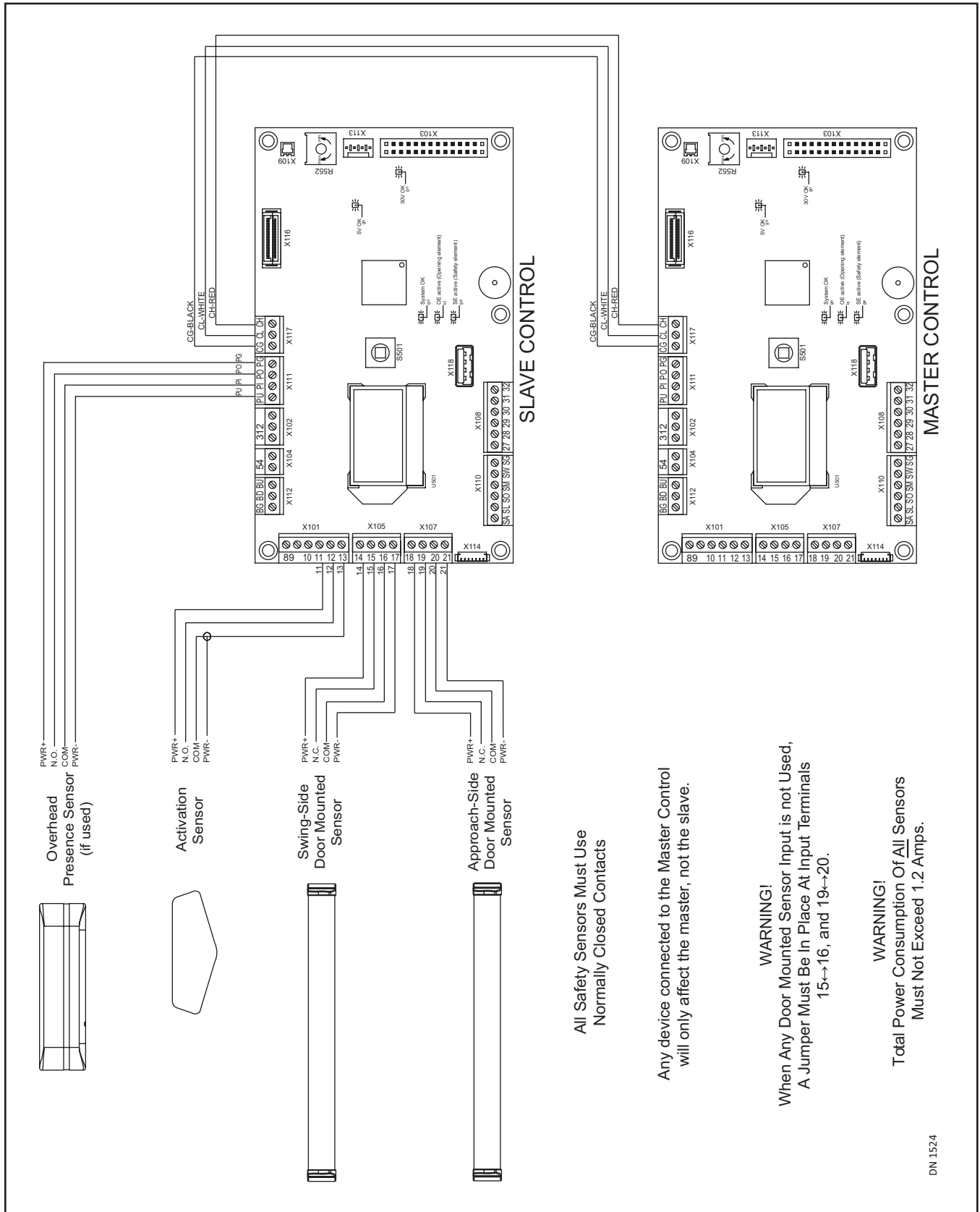

Overhead Presence Sensor (if used)

Activation Sensor

Swing-Side Door Mounted Sensor

Approach-Side Door Mounted Sensor

All Safety Sensors Must Use Normally Closed Contacts

Any device connected to the Master Control will only affect the Master Control, not the slave.

WARNING!
When Any Door Mounted Sensor Input is not Used, A Jumper Must Be in Place At Input Terminals 15↔16, and 19↔20.

WARNING!
Total Power Consumption Of All Sensors Must Not Exceed 1.2 Amps.

CHAPTER 6: INITIAL SETUP PROCEDURE

Section 6a: The Joystick

Notice: Elements/Values within all Menus are Password protected. When prompted for a password, push the Joystick three times to the left, then three times to the right.

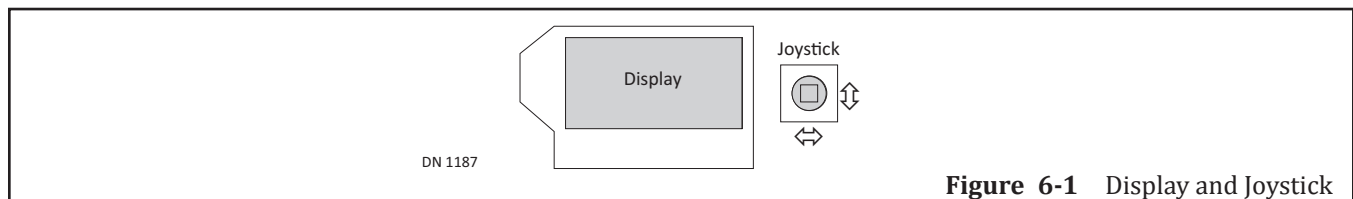

Figure 6-1 Display and Joystick

- ▶ To Enter Menu Pages from the Home Page:
 - Briefly push down on the Joystick.
- ▶ To select a Menu:
 - Move the Joystick to the Right to scroll through Menu options (Left to scroll backwards).
 - Briefly push down on the Joystick to (OK) selection.
 - The Element Page will be displayed.
 - If ESC is selected the Home Page will be displayed.
- ▶ To select or change an Element option:
 - Enter the Password (the Element Page will automatically be displayed).
 - Move the Joystick Down to scroll through Element options (Up to scroll backwards).
 - Briefly push down on the Joystick to (OK) selection.
 - The Value will start to blink (located on the lower half of the screen).
 - If ESC is selected the current Menu Page will be displayed.
- ▶ To change a Value option:
 - Move the Joystick to the Right or to the Left to change a Value.
 - Briefly push down on the Joystick to (OK) selection.
 - The Value will stop blinking, indicating that the new Value has been entered.
 - Move the Joystick Down to select another Element/Value option (Up to scroll backwards).
- ▶ To go back to previous Pages:
 - Push down on the Joystick until the Menu Page is displayed. Release the Joystick.
 - Push down on the Joystick again until the Home page is displayed. Release the Joystick.

Section 6b: Setup Procedure

WARNING

During the Setup procedure, all Safety Devices are ignored by the GT20 Control.

WARNING

Clear the area of any persons or objects in the path of moving Door Panel, in order to avoid injuries or damages.

WARNING

If the Parameters OHC-PH (push) and OHC-PL (pull) are confused, it can be dangerous for the Installer (because the door opens in the opposite direction).

Attention: Upon the first activation of opening the Door OR in the event the Door loses power: The Door will fully Open. About half way closing, the door will jerk stop (this is called Motor Damping). This is an UL Requirement to test the Spring. After Motor Damping the door will fully close.

Note: Values within the Setup Procedure are Password protected.

1. Go to the Power/Program Selector Switch. Flip the Power Switch ON.
 - a. The first Element Press Down will be displayed blinking upside down and right side up.



- a. First you have to choose between Europe/USA

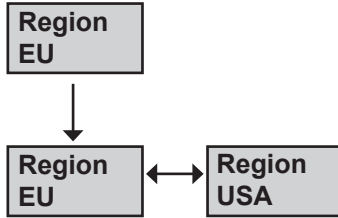

2. Move the Joystick up or down. The Element will stop blinking and be right side up for each circumstance.



3. Briefly push down on the Joystick. The Value will start to blink on the lower half of the screen.
4. Move the Joystick to the Right or to the Left to select(1) of the following Values.

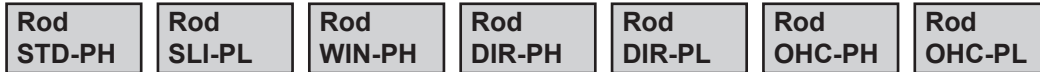

5. Briefly push down on the Joystick to (OK) selection.
6. Move the Joystick Down until the Element dAxis is displayed.



7. Briefly push down on the Joystick. The Value will start to blink on the lower half of the screen.
8. Move the Joystick to the Right or to the Left to select(1) of the following Values: 0cm...25cm
 - a. dAxis is an approximate Value. The installation may have to be adapted accordingly.

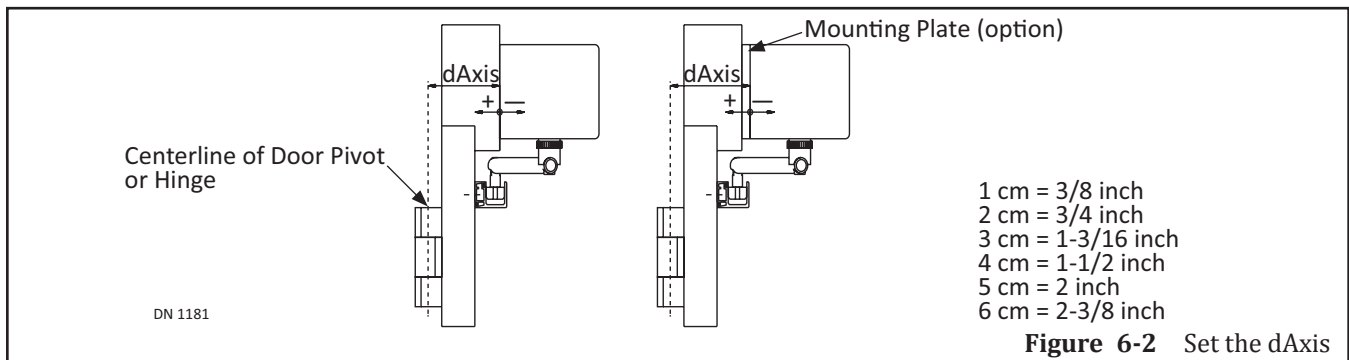

9. Move the Joystick Down until the Element A0 is displayed. the next Element A0 is displayed.

Ao
90°

10. Briefly push down on the Joystick. The Value will start to blink on the lower half of the screen.
11. Move the Joystick to the Right or to the Left to select(1) of the following Values: 20° ...190°
12. Briefly push down on the Joystick to (OK) selection.
13. Move the Joystick Down until the Element LowEn is displayed.

LowEn
OFF

14. Move the Joystick to the Right or to the Left to select(1) of the following Values.

LowEn
OFF

LowEn
ON

Note: Width and Weight Values are necessary in order to adjust for Low Energy Standards.

15. Briefly push down on the Joystick to (OK) selection.

Width
48 in

16. Move the Joystick to the Right or to the Left to select between 30 inches and 63 inches.
17. Briefly push down on the Joystick to (OK) selection.

Weight
200 lbs

18. Move the Joystick to the Right or to the Left to select between 100 pounds and 550 pounds.
 - a. Weight and Width values adjust for Low Energy Doors.
19. Briefly push down on the Joystick to (OK) selection.
20. Move the Joystick Down to until the Element Vo is displayed.

Vo
9

21. Briefly push down on the Joystick. The Value will start to blink on the lower half of the screen.
22. Move the Joystick to the Right or to the Left to select(1) of the following Values: 0...14
23. Briefly push down on the Joystick to (OK) selection.
24. Move the Joystick Down to until the Element Vc is displayed.

Vc
9

25. Briefly push down on the Joystick. The Value will start to blink on the lower half of the screen.
26. Move the Joystick to the Right or to the Left to select(1) of the following Values: 0...14

27. Move the Joystick Down to until the Element Inverse OFF is displayed.

Invers
OFF

28. Briefly push down on the Joystick. The Value will start to blink on the lower half of the screen.
29. Move the Joystick to the Right or to the Left to select(1) of the following Values ON or OFF.
30. Briefly push down on the Joystick to (OK) selection. Move the Joystick Down until the Element TEACH is displayed.

TEACH

WARNING

Clear the area of any persons or objects in the path of moving Door Panel, in order to avoid injuries or damages.

31. Ensure the Door Panel is fully closed.
32. Briefly push down on the Joystick. The Element Teach OK? will be displayed.

TEACH
ok?

33. Briefly push down on the Joystick to (OK) selection.
- The setup procedure (Teach) will begin.
 - The GT20 Control will start to beep with each second it takes for the Setup Procedure to complete the programming process (9 - 0).
 - After countdown, the Door Panel will OPEN to the (Ao) Open Position or to the Open Door Stop position (whichever comes first), and then CLOSE.
 - If the Door Panel opens much wider than the (Ao) angle programmed within the GT20 Control, the angle can be corrected by changing the dAxis Value. If the Door Panel continues to open at a much greater angle (Ao):
 - ▶ Ensure that the Swing Door was installed using the correct measurements.
 - ▶ Check the Swing Arm length, and the Swing Arm location on the Door Panel, and the Output Spindle location.
 - Upon completion of TEACH, the LCD screen will display the Home Page (Display will vary):

>##<
↔ EO1

34. Go to the Program Selection Switch.
35. Ensure the area is clear from any persons or objects in path of moving Door Panel.
36. Select the Door Open Icon.
37. The Door Panel will fully Open and then fully Close.

WARNING

!!! Every 24 hours, the GT20 Control automatically activates TEACH. The door will fully open and close without notice. The installer must wait (5) seconds before programming the GT20 Control after TEACH has been automatically activated !!!

Section 6c: Reset Back to Factory Default

1. From the Home Page, briefly push down on the Joystick. Move the Joystick to the Left until the REINIT Menu is displayed.

A rectangular screen with a light gray background and a black border. The word "REINIT" is centered in a bold, black, sans-serif font.

2. Briefly push down on the Joystick. Move the Joystick to the Right or Left until the Element FACTOR is displayed.

A rectangular screen with a light gray background and a black border. The word "FACTOR" is centered in a bold, black, sans-serif font. Below it, the word "Reset" is centered in a smaller, bold, black, sans-serif font.

3. Briefly push down on the Joystick.
 - a. The Element Reset OK? will be displayed

A rectangular screen with a light gray background and a black border. The words "Reset" and "ok?" are centered in a bold, black, sans-serif font, with "Reset" on the top line and "ok?" on the bottom line.

4. Briefly push down on the Joystick to (OK) selection.

CHAPTER 7: PROGRAMMING

Section 7a: The Four Levels of Menu Navigation

Table 7-1 Menu Levels

Level	Title	Description
1	Home Page	Displays the Door Panel state, the current Operating Mode, the Communication state for Astragal Swing Doors and Interlock Swing Doors, and an Active Error (if an error exists).
2	Menu Selection	Displays all available Menus.
3	Element Selection	Displays elements that can be selected within each Menu. Level 3 is password protected.
4	Changing Value	Displays values that can be changed within an Element. In most of cases, the Element is displayed on the first line with the current Value on the second line (second line blinks).

Section 7b: The Home Page

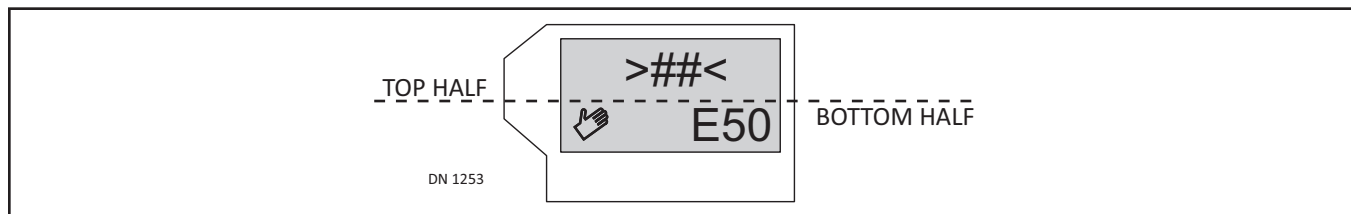

7.b.a: Top Half of Home Page

- ▶ Displays the Door Panel position - in real time. For example: If the Door Panel is closed and locked the >##< will be displayed. For example: If the Door Panel is programmed to stay open for (5) seconds before closing, the Door Panel will fully open, come to a stop, and then the LCD will not only display < 5 > the LCD Display will count down the seconds (5 - 0). At (0) the Door Panel will close.
- ▶ Displays Door Panel Control - in real time. For example: If an Exterior Sensor is activated, the acronym (OEO) will Display.

Table 7-2 Door Panel Position

Display	Description	Display	Description
<REF?>	Waits for reference switch	<< >>	Opening
< ?? >	Unknown	< >	Open
><	Closed	>> <<	Closing
>##<	Closed and locked	==	Stopping

Table 7-3 Door Panel Control

Display	Description	Display	Description
OEO	Exterior activation sensor (Exterior Activation Signal)	SER	Push side door mounted sensor (Approach Side Safety Signal)
OEI	Interior activation sensor (Interior Activation Signal)	SEF	Door mounted sensor for obstacle detection (Recycle Sensitivity)
KEY	Activation device for NIGHT mode (External Switch Activation Signal, Keyswitch, Card Reader, etc.)	EMY-IN	Emergency Open Input (Emergency Input Signal)
SES	Swing side door mounted sensor (Swing Side Safety Signal)	PUGO	Push-and-Go
PRE	Header Mounted Sensor on Swing Side		

7.b.b: Bottom Half of Home Page

- ▶ Displays what was programmed within the GT20 Control. For example: If the Door Panel was programmed to be in Teach Mode, both the Hand icon and Up Arrow Icon will display on the lower left hand corner.
- ▶ Displays Error messages. For example: If the setup procedure for (Teach) is not yet completed, the E11 Error message will display on the lower right hand corner. For detailed information on Errors please refer to the Troubleshooting Chapter.

Table 7-4 Door Panel Operation

#	Description
1	Program Mode (Selector Button). <i>Note: A frame around an Icon indicates: overriding Operating Mode.</i>
2	<ul style="list-style-type: none"> ▶ (m) means closing sequence - Master ▶ (s) means closing sequence - Slave ▶ (w) means Interlock
3	Active error

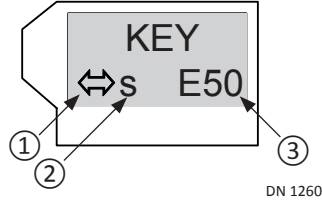

Swing door: in Night Mode; is opening; and communicating to a Slave door; (1) System Error

Section 7c: Menu Selection

Table 7-5 Menus

Menu	Description
PARAMETER	Sets the parameters for Swing door movement.
CONFIG	Configuration: Sets the parameters of the GT20 Control Features and Functions.
DOUBLE DOOR	Sets the Closing sequence and Interlock function.
DIAGNOSTICS	Diagnostic Tools that display the status of various inputs.
ERROR ACTIVE	<ul style="list-style-type: none"> ▶ Displays Pending Active Errors. ▶ Active Error list is updated with the latest additions appearing at the end. ▶ A0 indicates the latest Active error.
HISTORY ERROR	<ul style="list-style-type: none"> ▶ Displays all Active Errors that were detected and then corrected or not corrected. ▶ H0 indicates the latest Active error.
REINIT	Reinitialization resets Settings back to Factory Default
BLOCK?	Locks/Unlocks Joystick
UPDATE SW	Start the upgrade process from the USB Stick.
TEACH	<ul style="list-style-type: none"> ▶ Programs the Initial Setup, and finds Errors (if any). ▶ Programs a new Setup Procedure when deemed necessary. <p>!!! EVERY 24 HOURS, THE GT20 CONTROL AUTOMATICALLY ACTIVATES TEACH. THE DOOR WILL FULLY OPEN AND CLOSE WITHOUT NOTICE. THE INSTALLER MUST WAIT (5) SECONDS BEFORE PROGRAMMING THE GT20 CONTROL AFTER TEACH HAS BEEN AUTOMATICALLY ACTIVATED !!!</p>

Table 7-6 Parameter Menu: Settings for Door Panel Movement

Element	Unit Type	Default	Value	Description
Region	BOTH	EU	Eu or US	EU - Europe; US - United States
				Software version determined by UL Standards.
Vo	Full Power	6	0..14	Opening speed (velocity open)
	Low Energy	9	0..9	
Vc	Full Power	4	0..14	Closing speed (velocity closed)
	Low Energy	9	0..9	
TOEx	Full Power	3s	0..60s	TOEx sets the hold-open time resulting from activation signals from devices connected to: terminals 9+10 for exterior activation and terminals 12+13 for interior activation.
	Low Energy	3s	3..60s	
	ANSI 156.19 for Low Energy: TOEx must be <i>no less than 5s</i> .			
TKey	Full Power	5s	0..180s	<ul style="list-style-type: none"> ▶ TKey sets the hold-open time resulting from an activation signal from a device (referred to as KEY) on terminals 2+3. ▶ With TOEx and TKey, you can set a different hold open times for different activation devices by using different terminals.
	Low Energy	5s	3..180s	
TPuGo	Full Power	3s	0..180s	Determines how long the Door Panel stays open.
	Low Energy	3s	3..180s	
TDelay	Full & Low	0.2s	0.0..4.0s	TDelay sets the amount of time the door hesitates to allow the lock to release before opening.
FDelay	Full Power	OFF	OFF..7.0A	FDelay is a temporary "hold closed" force applied to the door to keep it closed while the electric lock is being released. This parameter sets the amount of force that is applied. FDelay is only active if TDelay setting is greater than 0.
	Low Energy	OFF	OFF..7.0A	
TLock	Full & Low	0.5s	0.0..4.0s	Sets amount of time Door Panel will press against lock to engage it.
FLock	Full & Low	2.0A	OFF..7.0A	Sets amount of force that is applied to the door to engage the lock at the closed position. It is only active if TLock setting is greater than 0.
FSlam	Full & Low	OFF	OFF..10	Accelerating function (force slam). For example: When a door panel needs to be forced shut due to a latch or heavy seals.
FWind	Full & Low	OFF	OFF	<ul style="list-style-type: none"> ▶ Obstacle detection optimized for exterior doors (wind loads). ▶ Assuming that a gust of wind is not a hard obstacle which will stop the door, the motor current will rise "slowly". In this case the GT20 Control will provide additional power to continue the door movement. ▶ When FWind is turned ON, Nabco strongly recommends the use of door mounted sensors to stop or re-open the door if an obstacle is detected during the door cycle.
			OPEN	
			CLOSE	
			BOTH	
Fo	Full Power	4	0..9	▶ Opening force (force open) when an obstacle is detected during Open/Close cycle or both.
	Low Energy	9	0..9	
Fc	Full Power	4	0..9	▶ In standard mode Obstacle Detection can not be switched On/Off. It can be adjusted with parameters "Fo" = Opening force (force open) and v "Fc" = close force (force close). To make Obstacle Detection least sensitive: set both parameters on max. (= step 9). To make Obstacle Detection most sensitive: set both parameters on min. = 0 (caution this can allow the drive to react to small changes in wind).
	Low Energy	9	0..9	
Foh	Full & Low	4	0..9	Hold-open force (force open hold)
Fch	Full & Low	0.0A	0.0A..3.5A	<ul style="list-style-type: none"> ▶ Interlocking Force (force close hold): automatically programs FLock and FDelay if these settings are set at 0. ▶ If there is no electric lock and the Interlocking Force Fch is not adjusted, Error 14/02 will be displayed as a warning after the Teach1 procedure and the Door Panel will endlessly re-open.

Element	Unit Type	Default	Value	Description
LowEn	Low Energy	OFF	OFF	Door Panel is Full Power in both directions
			ON	<ul style="list-style-type: none"> ▶ Door Panel is Low Energy in both directions ▶ Door Panel is activated by a Knowing Act
			Width	30in... 48in
			Weight	100lbs... 200lbs
Ao	Full & Low	90°	20°...190°	Opening angle of the door (angle open)
				Teach must be activated after this setting has been changed.
Rod	Full & Low	STD-PH	STD-PH	Outswing Arm and Arm Shoe
				Push Function = Right Hand Motor Cable Connector: X = Orange
			SLI-PL	Inswing Arm and Track
				Pull Function = Left Hand Motor Cable Connector: Y = Green
			SLI-PH	Inswing Arm and Track
				Push Function = Right Hand Motor Cable Connector: X = Orange
			WIN-PH	Non-Applicable
				Non-Applicable
			DIR-PH	Outswing Arm and Track
				PushFunction = Right Hand Motor Cable Connector: X = Orange
DIR-PL	Outswing Arm and Track			
	Pull Function = Left Hand Motor Cable Connector: Y = Green			
OHC-PH	Overhead Concealed			
	Push Function = Right Hand Motor Cable Connector: X = Orange			
OHC-PL	Overhead Concealed			
	Pull Function = Left Hand Motor Cable Connector: Y = Green			
				<ul style="list-style-type: none"> ▶ If panic breakout latch is installed and the motor is plugged in backwards or the wrong arms are chosen during programming, there is a possibility the door can burst open unexpectedly towards the installer once TEACH mode is initiated. ▶ Teach must be activated after this setting has been changed.
Inverse	Full & Low	OFF	OFF...ON	In the event of a power failure/error, the Door Panel is opened by spring power from any position (unless it has been locked). The position of the motor connector is reversed with regard to the standard drive unit.
				Teach must be activated after this setting has been changed.
AcSeq	Full & Low	0°	0°... 105°	Delay Angle for Master opening sequence control.
TcSeq	Full & Low	1.5s	0.0...?	Delay Time for Master to begin to close the Door.
AoSeq	Full & Low	0°	0°... 105°	Delay Angle for Slave opening sequence control.
dAxis	Full & Low	2.8in	-3.2...10in	Distance between center line of the door hinges and the mounting surface of the Operating Assembly. dAxis is an approximate value. Depending on the installation situation, dAxis may have to be estimated.
				Teach must be activated after this setting has been changed.

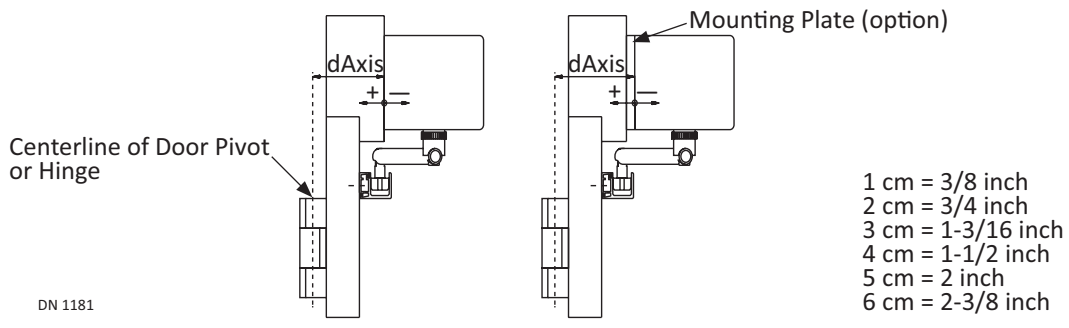

DN 1181

Table 7-7 Configurator Menu: Settings for Door Panel Functions

Element	Default	Value	Description
APuGO	OFF	OFF, 2°...10°	Triggering angle for Push&Go (angle push&go).
ASES	95°	45°...95°	Lock out angle: ▶ Angle at which swing side door mounted sensor is ignored just before open. ▶ If Ao is changed, ASES is automatically set to Ao.
ASER	0°	0°...60°	Lock out angle: Angle at which push side door mounted sensor is ignored just before closing.
Element	Default	Value	Description
SESClo	INACTIVE	ACTIVE	Sensor mounted on Swing side of Door Panel is activated or inactivated during closing cycle.
		INACTIVE	
EMY-IN	CL-SPR	Configuration of the Emergency terminal (break contact) (emergency input)	
		CL-SPR	Spring Close (Standard Application)
		STOP	Stops Door Panel Closing/Opening
		OPEN	Opens Door Panel
		CL-MOT	Motor Close (Inverse Application)
OExSTp	OFF	OFF	N/A
		OEI	Opening Element Inside
		OEO	Opening Element Outside
		KEY	Opening Element NIGHT
		RADIO	N/A
UNLOCK	PERMAN	IMPULS	When the Door Panel is first open: Momentarily unlocks Electric Lock.
		PERMAN	When the Door Panel is first open: Permanently unlocks Electric Lock.
EL-Fb	OFF	Return signal of Electric Lock (feed back). (+) and (-) indicates status in the diagnostic menu.	
		OFF	N/A
		N.O.	N.O. Contact ▶ open if in the unlocked state (-) ▶ closed if in the locked state (+)
		N.C.	N.C. Contact ▶ open in the locked state (+) ▶ closed in the unlocked state (-)
LcdDir	0	0...1	Orientation of the display (LCD direction)
MovCon	OFF	OFF	Endurance test Open/Close (moving continuous)
		ON-FLT	
		ON-PRM	
OExMAN	ON	OFF-ON	Acceptance of opening commands after a manual door opening. <i>Note: OExMAN only if APuGo is turned OFF.</i>

Element	Default	Value	Description	
The following Table is only displayed when an optional Relay Board is installed				
RC 0.1	CLOSED		Only (1) PCB Terminal per Switch Activation is allowed. For example (2) activations (during closing and opening) must be wired to (2) different PCB Terminals. <i>Note: The Configurator Menu will only display the following Elements/Values when the Relay PCB Board is installed.</i> <i>Note: NABCO does not install more than (1) Relay PCB Board.</i>	
RC 0.2	OPEN			
RC 0.3	ERROR			
RC 0.4	GONG			
	CLOSED			Relay switches when the Door Panel is fully closed.
	OPENNG			Relay switches when the Door Panel is opening.
	OPEN			Relay switches when the Door Panel is fully open.
	CLOSING			Relay switches when the Door Panel is closing.
	ERROR			Relay switches if the GT20 Control detects an Error(s).
	PSAUTO			Relay switches when the Program Selector is in Mode: AUTOMATIC
	PSNIGHT			Relay switches when the Program Selector is in Mode: NIGHT
	PSEXIT			Relay switches when the Program Selector is in Mode: EXIT
	PSOPEN			Relay switches when the Program Selector is in Mode: OPEN
	PSMANU			Relay switches when the Program Selector is in Mode: MANUAL
	GONG		Relay switches <i>momentarily</i> during the time the GT20 Control receives a signal from: Terminal 12 and Terminal 13 (Opening Command Inside).	
	LOCKED		Relay switches during the time the Door Panel is LOCKED with an electric lock.	

Table 7-8 Double Door Menu: Settings for Closing Sequence and Interlock Function

Element	Default	Value	Description
Dubled	OFF	MastrA SlaveA	Doors Panels installed SidebySide.
InterL	OFF	Side A Side B	Two individual door Panels that are connected by CAM Bus. One Door Panel cannot open if the other door is open. Also known as AirLock or Mantrap.

Table 7-9 Diagnostic Menu: Diagnostic Tool

Element	Description
K-I-O-R-S-P -E	Displays all Input Commands (+) Active, (-) Inactive. Read Only, can not edit. (K) Key Night Mode Activation Devise (I) OEI Interior Activation Sensor (O) OEO Exterior Activation Sensor (R) SER Push Side Door Mounted Sensor (S) SES Swing Side Door Mounted Sensor (P) Swing Side Header Mounted Presence Sensor (E) EMY-IN Emergency Open Input
-0.0A; 0°	Displays Motor Current and the Swing door opening angle (Example: 5.1A; 95°).
x.yA / z°	Displays actual current used by the Motor and the current Angle of the Door Panel.
X°C / y z	Displays the: ▶ Current temperature measured on the PCB (Logic Print) on the first and second line. ▶ Current minimum and maximum temperature since the last reset system. OK will reset any/all stored (Min/Max. Values)
SimulateKey	Key Command that opens the Door Panel by pressing OK
E-Lock	L Displays the status of the Lock. L+ Locked L- Unlocked FB Displays input El-FB. Press OK to actuate the Electric Lock. FB+ Locked FB- Unlocked
PG Version	Packaged Software
SW Version	Version of Software

Element	Description
UL Version	Software changed due to UL specifications
HW Version	Version of Logic PCB
Cycles	Total number of openings (this value is memorized).
R0 R1 FP RP	Displays what the Door Panel is doing.
R0	Relay print with address 0
	- Identified and ready for operation
R1	N/A
	+ Neither identified nor registered
FP	N/A
	a Defective or Error
RP	N/A
	x Removed

Table 7-10 Error Active: For detailed Error Tables please refer to Chapter 18.

Element	Description
ERROR ACTIVE	Error Active list is updated with the latest additions appearing at the end. A0 indicates the most recent Active Error.

Table 7-11 History Error

Element	Description
HISTORY ERROR	List of Active Errors that were detected and corrected or not corrected. H0 indicates the most recent Active Error

Table 7-12 REINIT Menu: Reverts Settings back to Factory Default

Element	Description
FACTORY RESET	All settings that were programmed into the GT Control will be reset to Factory Defaults.
PARAM RESET	Resets/Sets all motional Parameters back to the default values (inclusive opening angle, rod assemblies, Invers and dAxis
CONFIG RESET	Reset sets all the configuration settings back to the default values.
DOUBLE RESET	Reset sets all the closing sequence and interlock settings back to the default values.

Table 7-13 Block/Unblock Menu: Lock Keys

Menu	Description
Block?	To lock the Joystick Press OK for 2 seconds The Display shows temporarily BLOCK!
UBLOC?	To unlock the Joystick Press OK for 2 seconds The Display shows temporarily UBLOC!
BlockD	When the Joystick is blocked, the "Home display" shows BLOCKD , if the Joystick is operated!

Table 7-14 Update SoftWare: For detailed Software Update instructions please refer to Chapter 19.

Element	Description
Update SW	Updates the latest version of software.

Table 7-15 Teach Menu

Element	Description
TEACH OK?	Programs the Setup Procedure within the GT20 Control.

CHAPTER 8: DOUBLE SWING DOORS

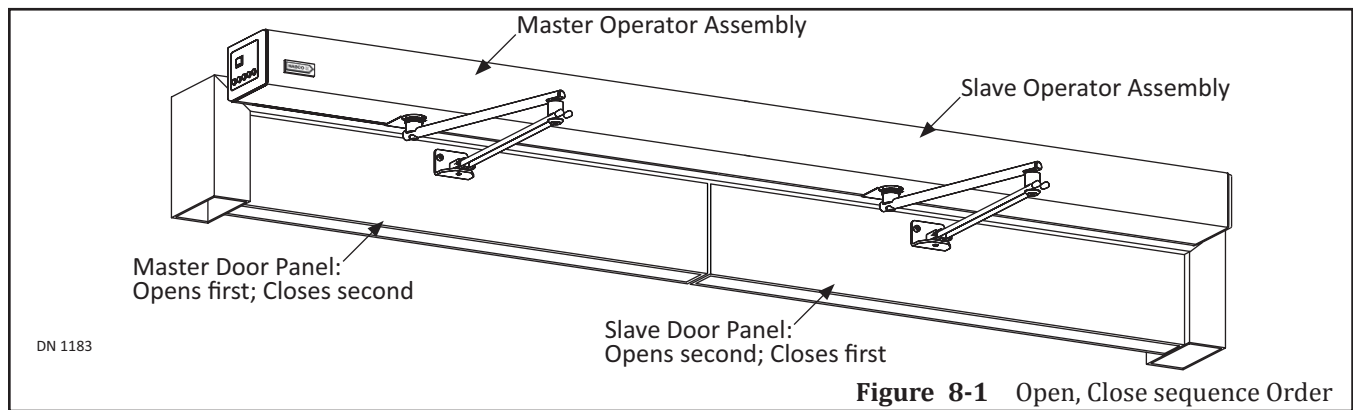

Section 8a: Activation Input Connections:

Activation Inputs:

- ▶ (KE) Night Mode
- ▶ (OEO) Exterior Activation Sensor
- ▶ (OEI) Interior Activation Sensor

Connected to the:

- ▶ Master Door Panel
 - Will open the Master door only.
- ▶ Slave Door Panel
 - Will force the Master Door Panel to open first and then the Slave Door Panel second.

Section 8b: Safety Element Connections:

Safety Elements that are connected to their respective GT20 Controls:

- ▶ (SER) Push side door mounted Sensor (for re-opening the door).
- ▶ (SES) Pull side door mounted Sensor (for stopping the door).

Section 8c: EMY-IN Sensor Connections:

An active (EMY-IN) Emergency Input Signal Sensor connected to the:

- ▶ Master Door Panel
 - Will force the Master Door Panel to open first and then the Slave Door Panel second.
- ▶ Slave Door Panel
 - Will force the Slave Door Panel to open first and then the Master Door Panel second.

Section 8d: Electric Lock Connections:

An electric lock, that is connected to the:

- ▶ Master Operator Assembly
 - Locks the Master Door Panel
- ▶ Slave Operator Assembly
 - Locks the Slave Door Panel

Section 8e: Open/Close Settings

1. Select the Parameter: DupleD (Closing Sequence Role Master/Slave)
2. Select the Setting Range:
 - ▶ MastrA:
 - To activate the Master Door Panel first
 - ▶ SlaveA:
 - To activate the Slave Door Panel second
 - a. If a CANbus connection exists between the GT20 Controls, the Master is identified by a small black (m) and the Slave by a small black(s).
 - b. If a CANbus connection does not exist, the Master is identified by a small white (m) and the Slave by a small white (s).
3. Select the Parameter: VO (Opening Speed)
4. Select the Setting Range: 0 - 14 seconds
 - a. Each GT20 Control is independent from each other. It is possible to select a different setting range if deemed necessary. For example: Master: Vo = 4 seconds; Slave: Vo = 5 seconds
5. Select the Parameter: AoSeq (Delay angle for Slave opening sequence control)
6. Select the Setting Range: 0 - 105 degrees
 - a. The default AoSeq setting is 0 degrees.
 - b. AoSeq = the Slave will start to open after the Master exceeded the opening angle of 20 degrees.
 - c. Once the Slave starts to open - it is possible for the Slave to catch up with, and then pass the Master. If this is required, select a higher VO Setting Range for the Slave Door Panel.
7. If an electric lock is installed on the Master, select the Parameter: TDelay (Time Delay).
8. Select the Setting Range: 0 - 4 seconds
 - a. TDelay sets the amount of time the Master needs to hesitate in order to allow the electric lock to release before opening.
 - b. When the Setting Range for TDelay is set higher than 0 seconds, the AoSeq angle between the Slave and the Master is increased. AoSeq must be reduced.
 - c. An AoSeq value of 0 degrees means that both Door Panels will simultaneously open (no opening delay is active).
9. Select the Parameter: AcSeq (Delay angle for Master closing sequence control)
10. Select the Setting Range: 0-105 degrees.
 - a. The default AcSeq setting is 0 degrees.
 - b. The Master will start to close after the Slave exceeded the closing angle of 20 degrees.
 - c. This advance guarantees the Master and Slave close in one smooth closing motion.
 - d. If the Master closing speed is set so the Master overtakes the Slave while closing, the Master will stop at the 20 degree angle to allow the Slave to fully close first.

Section 8f: Sensor Signals

- ▶ A SES signal from the PULL side of a Swing Door Panel:
 - Will cause a safety stop for both Door Panels.
- ▶ A SER signal from the PUSH side of a Swing Door Panel:
 - Will cause a both Door Panels to stop closing and re-open.

Section 8g: Emergency Stop

An Astragal Swing Door Unit can be operated in a single Door Panel mode. An active EMY-IN signal on the Slave programs the closing sequence as a single Door Panel configuration. If only the EMY-IN signal on the Master is active, then this EMY-IN signal is applicable for both Door Panels. In accordance with the action configured on the Master by means of EMY-IN, both Door Panels carry out a CL-SPR (Close Spring), STOP, OPEN or CL-MOT (Close Motor).

If only the EMY-IN signal on the Slave is active, then the Slave carries out a CL-SPR, regardless of the action configured on the Slave by means of EMY-IN. If both EMY-IN signals are active, then the Master performs its configured EMY-IN action and the Slave performs a CL-SPR. One exception of this rule is the Master in the EMY-IN configuration OPEN. In this case, both Door Panels will be opened.

Note: The respective control and safety sensor are connected to the corresponding drive unit.

1. Plug both ends of (1) CAN Cable into each (Socket X117) located on each GT20 Control, to connect both Operator Assemblies.
2. Go to the Master GT20 Control. Select the Parameter EMY-IN. Select the Setting Range: Open
3. Go to the Slave GT20 Control. Select the Parameter EMY-IN. Select the Setting Range: Open
4. Go to the Master GT20 Control. Select the following parameters:
 - ▶ DupleD = MastA
 - ▶ AcSeq = desired time lag of the closing angle.
5. Go to the Slave GT20 Control. Select the following parameters:
 - ▶ DupleD = SlaveA
 - ▶ AoSeq = desired time lag of the opening angle.

Section 8h: Check Connections

Note: A small white (m) and a small white (s) indicates: a missing connection.

1. Check the LCD Display on the Master GT20 Control to see if a small black (m) is visible on the first level (connection existing).
2. Check LCD Display on the Slave GT20 Control to see if a small black (s) must be visible on the first level (connection existing).
3. Transmit a Key (open) command to the Slave control by applying a Jumper to Terminals 2 & 3.
 - a. The Master will be the first one to open, followed by the Slave.
 - b. In the open position the hold-open time expires on the display of the Slave control.
 - c. The Slave is first to close, followed by the Master.

Section 8i: Interlock Operation

Note: Both Operator Assemblies must be running off the same power circuit.

1. Plug both ends of (1) CAN Cable into each (Socket X117) located on each GT20 Control, to connect both Operator Assemblies.
2. Program both GT20 Controls for standard open speed, close speed, etc. as required.
3. For the Exterior Door Panel (A), select the Parameter: InterL
 - a. Please see Figure 8-2.
4. Select the Setting Range: SideA

5. For the Interior Door Panel (B), select the Parameter: InterL
6. Select the Setting Range: Side B

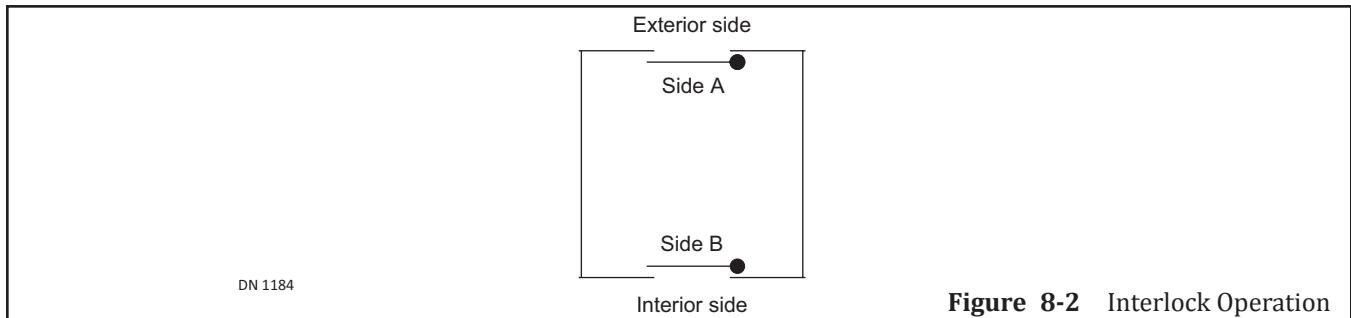

Figure 8-2 Interlock Operation

Section 8j: Check Connections

Note: A small white (m) and a small white (s) indicates: a missing connection.

Note: Both Operator Assemblies must be running off the same power circuit.

Note: Parameters: ILAuto, ILExit and ILNigt enable yo to configure the operating modes in which the Interlock system shall be active.

1. Check the LCD Display on the Master GT20 Control to see if a small black (w) is visible on the first level (connection existing).
2. Transmit a Key (open) command to the exterior control (A) by applying a jumper to terminals 2 & 3:
 - ▶ The LCD will display a big black (W) (door is not closed).
 - ▶ While the exterior door (A) is open, transmit a Key command to the interior Control (B) (the latter must not open).
3. Transmit a Key command to the interior Control (B):
 - ▶ On the display a big black (W) appears (door is not closed).
 - ▶ While the interior door (B) is in the open position, transmit a Key command to the exterior (A) (the latter must not be opened).

CHAPTER 9: RELAY PRINT

- ▶ The Relay PCB Board is strictly used for monitoring purposes and is optional only. For example: Fire Alarm Systems, or Security Alarm Systems.
- ▶ The Relay PCB Board OUTPUTS information only.
- ▶ NABCO does not install more than (1) Relay PCB Board.
- ▶ The Relay PCB Board Address is (R0).
 - If (2) Relay PCB Boards were installed onto the GT20 Control the second Relay PCB Board would be addressed as R1.
- ▶ The status of the Door Panel during Real Time is displayed within the Diagnostic Menu.
- ▶ Values for Elements (RC 01...RC 04) can be changed within the Configuration Menu.
- ▶ The Relay PCB Board (R0) must be installed before the Configuration Menu can display the Elements/Values or the Diagnostic Menu can display the Status of the Door Panel.

Section 9a: Install the Relay PCB Board.

DANGER

Shut Breaker OFF. Failure to do so may result in serious personal or fatal injury. When uncertain whether power supply is disconnected, always verify using a voltmeter.

DANGER

Do not place finger or uninsulated tools inside the electrical GT20 Control. Touching wires or other parts inside the enclosure may cause electrical shock, serious injury or death.

1. Ensure the Power is OFF.
2. Use a T-10 Torx Allen Wrench to remove (4) M3 x 5 Torx Screws used to secure the GT20 Control Board. Set Aside. Please see Figure 9-1.
 - a. The (4) Torx screws are located at (2) corners on the opposite side of the Terminal Strips and (2) middle location on the opposite side of the Relay PCB Board Connector Strip.

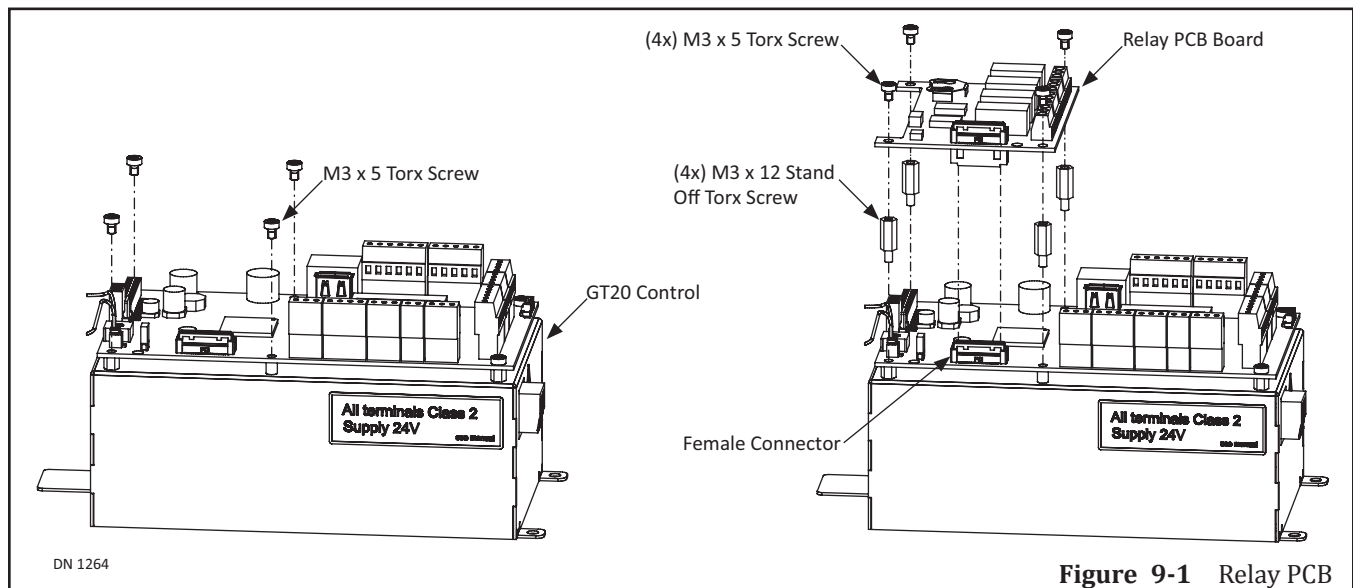

Figure 9-1 Relay PCB

3. Insert (4) M3 x 12 Stand Off Torx Screws within each screw hole.
4. Secure the Relay PCB Board onto the GT20 Control with (4) M3 x 5 Torx Screws.
5. Proceed to wire each PCB Terminal accordingly.

Section 9b: Program the Relay PCB Board

1. Switch-on the Main Power Switch.
 - a. The Home Page will be displayed.



2. Briefly push down on the Joystick.
 - a. The Menu Selection Page will be displayed.
3. Move the Joystick to the Right or Left until the Menu CONFIG is displayed.



4. Briefly push down on the Joystick.
 - a. An Element Page will be displayed.
5. Move the Joystick Down until the Element RC 0.1 is displayed.

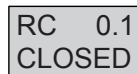

6. Briefly push down on the Joystick. The Value will start to blink on the lower half of the screen.
7. Move the Joystick to the Right or to the Left to select(1) the appropriate Value. For details, please see Table 18-1.
8. Repeat steps 5 thru 7 until all Relay PCBs are programmed within the GT20 Control.
9. Go back to the Menu Page:
 1. Push down on the Joystick until the Menu Page is displayed.
10. Move the Joystick to the Right or Left until the Menu DIAGNOSTICS is displayed.



11. Briefly push down on the Joystick.
 - a. The Element Page will be displayed.
12. Move the Joystick to the Right or Left until the Element RO+ R1- FP- RP- is displayed. For details please see Table 18-2.

Table 9-1 The Configuration Menu for the Relay PCB Board

RC 0.1	CLOSED	<p>Only (1) PCB Terminal per Switch Activation is allowed. For example (2) activations (during closing and opening) must be wired to (2) different PCB Terminals.</p> <p><i>Note: The Configurator Menu will only display the following Elements/Values when the Relay PCB Board is intalled.</i></p> <p><i>Note: NABCO does not install more than (1) Relay PCB Board.</i></p>	
RC 0.2	OPEN		
RC 0.3	ERROR		
RC 0.4	GONG		
	CLOSED		Relay switches when the Door Panel is fully closed.
	OPENNG		Relay switches when the Door Panel is opening.
	OPEN		Relay switches when the Door Panel is fully open.
	CLOSING		Relay switches when the Door Panel is closing.
	ERROR		Relay switches if the GT20 Control detects an Error(s).
	PSAUTO		Relay switches when the Program Selector is in Mode: AUTOMATIC
	PSNIGHT		Relay switches when the Program Selector is in Mode: NIGHT
	PSEXIT		Relay switches when the Program Selector is in Mode: EXIT
	PSOPEN		Relay switches when the Program Selector is in Mode: OPEN
	PSMANU		Relay switches when the Program Selector is in Mode: MANUAL
	GONG	Relay switches <i>momentarily</i> during the time the GT20 Control recieves a signal from: Terminal 12 and Terminal 13 (Opening Command Inside).	
	LOCKED	Relay switches during the time the Door Panel is LOCKED with an electric lock.	

Table 9-2 The Diagnostic Menu for the Relay PCB Board

Diagnostic Element	Address	Description
R0+R1- FP-RP-	Displays what the Door Panel is doing	
	R0	Address for Relay Board (RC 0)
	R1	N/A
	FP	N/A
	RP	N/A
Status Symbol	+	Identified and ready for operation
	-	Neither identified nor registered
	e	Defective or Error
	x	Removed

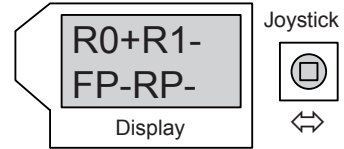

Only (1) Relay PCB Board (R0) has been installed

CHAPTER 10: TROUBLESHOOTING

WARNING

Electrocution hazard! Before working on any live elements, disconnect 120 VAC from unit. If a malfunction occurs, which might be detrimental to the safety of users, and cannot immediately be repaired. The owner must be informed. The installation shall be taken out of operation and must be repaired as soon as possible.

Note: Every troubleshooting procedure which is carried out must be entered into the control booklet. Never leave an unsafe door operational. If the door is not immediately repairable, turn off equipment. Advise the owner that the door should not be used until repairs are made

Section 10a: Malfunction with Error - No

Note: Error is indicated on the display of the Control Unit.

Please see below to define the "Reaction" column located within Table 9-1.

- ▶ A = Drive Unit deactivates itself during a certain period: Manual operating mode or stopping position.
- ▶ F = Fatal error
- ▶ H = Manual operating mode with re-starting attempt.
- ▶ W = Warning
- ▶ A0 = (A) Active Error; (0) Most recent Error

Table 10-1 Drive Mechanism

No	Description	Cause	Elimination	Checking Time	Reaction	
E1	01 02 03 04 05 06 07 08 09 10 11 12 13	Encoder	Channel A Lost	<ul style="list-style-type: none"> ▶ Check: <ul style="list-style-type: none"> • Encoder Connection • Motor Cable • If Jumper is inserted on X106 ▶ Direction of motor rotation does not match swing side of door ▶ Door is blocked 	During Run	H
			Channel B Lost		Prior to Start-Up	H
			Channel A + B Lost		During Encoder Test	H
			Short-Circuit A + B		Prior to start-up	H
			Malfunctions		During Test	H
			Motor Cable incorrectly plugged in		Always	H
			No signal channel A			
			No signal channel B			
			No signal channel A + B			
			Short-circuit A + B			
			Malfunctions			
			Malfunctions			
			Encoder not connected			
E2	02	Motor Current	Current too High	<ul style="list-style-type: none"> ▶ Check: <ul style="list-style-type: none"> • Motor Cable • If Jumper is inserted on X106 	Prior to start-up	H
			Current too Low			
			Jumper missing			
E3	01 02	Latch Check (cushioning)	Test Failed Once	Switch the Drive Unit to MANUAL Operating Mode. Then carefully check if the door closes in a cushioned manner: <ul style="list-style-type: none"> ▶ If Not: Replace Hardware ▶ If Yes: Check/correct the friction of the Door Panel and the pre-stressing of the closing spring 	Prior to closing cycle (after startup)	W F (Drive unit is functioning Buzzer Active)
			Test Failed Twice			
			Damping Defective			
			Opening beyond range of Operator			

No	Description	Cause	Elimination	Checking Time	Reaction
E4	01 Reference Switch	Range of Operator detected in the Open Position	<ul style="list-style-type: none"> ▶ Check: <ul style="list-style-type: none"> • The Connection • Switching Point of the Reference Switch ▶ Reference Switch must be activated in Close position (Switching Contact open) 	Open Position	F
		Not detected in the Closed Position		<ul style="list-style-type: none"> ▶ Before Start (Teach) door must be in Open position ▶ Reference Switch must be activated in Open position (Switching Contact open) 	Prior to the First Setup Run
		Not detected in the Closed Position			
		Not detected in the Open Position in "INVERS" mode			
E5	00 Power Limitation	<ul style="list-style-type: none"> Control Overload Maximum Power is Restricted 	<ul style="list-style-type: none"> ▶ Check/Correct <ul style="list-style-type: none"> • Friction of the Door Panel • Pre-Load of Closing Spring ▶ Ensure maximum door weight is not exceeded 	Permanent	A

Table 10-2 Operating

No	Description	Cause	Elimination	Checking Time	Reaction
E10	01 Fullteach required	Parameter Ao, Rod, Invers or dAxis changed	▶ Carry out a learn cycle	Upon changing the drive unit configuration	H
		Minimum opening angle has not been achieved	▶ Check the locking/ electric lock	During Teach	H
E11	01 Halfteach required (Opening)	Parameter Vo changed	▶ Carry out a complete and unhindered opening cycle	Upon changing the speed parameters	W
	02 Halfteach required (Closing)	Parameter Vc or FSlam changed	▶ Carry out a complete and unhindered closing cycle		
E14	01 Locking/Electric Lock	The Door panel got caught in the locking/ electric lock	Check the function of the locking/ electric lock	When opening from a closed position	H
		The inverted operation has no locking, or the interlocking force Fch has not been programmed	Program/increase the interlocking force Fch	At the end of the teach procedure	W
E15	01 Obstacle during opening	Too many successive obstacles have occurred	<ul style="list-style-type: none"> ▶ Examine the installation ▶ Remove the obstacle ▶ Move the Door panel to the target position 	Permanent	H, A Restart after 60's
	02 Obstacle during closing				
E16	01 Temperature	Temperature on output level has reached 178° F	▶ Allow the unit to cool down	Permanent	A Drive unit functions with reduced power
		Temperature on output level has reached 196° F			A Drive unit has stopped

Table 10-3 Safety Sensors

No	Description	Cause	Elimination	Checking Time	Reaction	
E20	01	SER Test	SER Test signal unsuccessful	SER short-circuit to the earth. Check the cabling of the sensor or the jumper	Prior to closing	A
	02		SER too slow	SER reacts too slowly Check the cabling of the sensor Check for polarity reversal/test signal	E20-01 and E20-02 together, no line in between, like E21	
E21	01	SES Test	SES Test signal unsuccessful	SES short-circuit to the earth Check the cabling of the sensor or the jumper	Prior to opening	A
	02		SES too slow	SES reacts too slowly Check the cabling of the sensor Check for polarity reversal/test signal		
E22	01	NOT Test	NOT input on 24 V	Check the jumper NOT Check the cabling of NOT	Permanent	H
	02		Malfunction	Restart the control unit SW Update necessary	After Power Up	

Table 10-4 Power

No	Description	Cause	Elimination	Checking Time	Reaction	
E30	01	30 V Error	30 V too low	Mains failure, overload motor Check 115 VAC line. Replace hardware	Permanent	A
	02		30 V too high			
	03		Error upon switching-on		After Power Up	
E31	01	24 V General	Error upon switching-on	Overload, short-circuit of the 24 V inputs (without electric lock, Safety Sensors)	After Power Up	A (Restart after 10 s)
	02		Over-resp under-voltage		Permanent	
E32	01	24 V Safety	Over-resp under-voltage	Overload, short-circuit Safety Sensors		
E33	01	24 V E-Lock	Error: Over-resp under-voltage	Overload, short-circuit electric lock		
	02		Premonition: Over-resp under-voltage			
E34	01	24 V CAN	Over-resp under-voltage	Overload, short-circuit external power supply CAN		

Table 10-5 Option

No	Description	Cause	Elimination	Checking Time	Reaction	
60	00	Relay PCB 0	Option PCB has been removed, its address changed or became defective	► Check if the option is provided. ► If defective: Replace or remove from the configuration.	Permanent	W
	10	Relay PCB 1				W
	20	Radio PCB				W
	30	Fire-Protection				A

Table 10-6 System

No	Description	Cause	Elimination	Checking Time	Reaction
E50	01-99 System Error	Unexpected hardware or software event	Switch the drive unit Off/On Carry out a Factory Reset, carry out a Software Update, inform the manufacturer	Permanent	W or H or F
E51					
E52					

Table 10-7 Closing Sequence / Interlock Function

No	Description	Cause	Elimination	Checking Time	Reaction
70	xx	CAN bus setting	CAN address xx existing twice	Correctly define the role of the Closing Sequence or the Interlock Function	Permanent W
E71	01	CAN connection	No CAN connection	<ul style="list-style-type: none"> ▶ Plug in, check or replace the CAN cable ▶ Check if all the CAN participants are switched on 	Permanent W

Table 10-8 UL Test

No	Description	Cause	Elimination	Checking Time	Reaction
E80	01	Continuous Routine	Malfunction	--	Permanent W
	02			Power Down then Power Up	
E81	01	mcu Routine		--	▶ Before: • Opening Door • Closing Door W
	02			Power Down then Power Up	
E82	01	Dynamic Routine	Damping Test Failed	--	After Power Down then every 24 hrs when door is closing W
	02			Power Down then Power Up	
E83	01	Static Routine	Motor Current Test Failed	--	After each closing movement (in Closed position) W
	02			Power Down then Power Up	

Section 10b: Malfunction without an Error Code

In some cases, it is technically impossible to display a malfunction by an Error number. For this reason the list shown below contains some probable causes as well as the corrective action to be taken.

Table 10-9 Closing Sequence / Interlock Function

Erroneous Behavior	Analysis	Possible Causes	Remedy
Drive unit fails to react: ▶ No automatic opening ▶ No activation from sensors, Power/Mode Switch buttons or Mode buttons on side cover.	▶ The program selection keys in the side cover are not lighted ▶ LED 5 V (green) on the control is not lighted	Power supply voltage is missing	▶ Switch on the main installation switch in the side cover ▶ Measure the mains supply voltage, check its cabling and eliminate any detected deficiencies ▶ Should the two above mentioned measures not be successful, the control unit needs to be replaced
Drive unit fails to open	▶ LED SE (Safety Sensor, yellow) is lit ▶ Determine which safety sensor is active via the diagnostic level	One or more Safety Sensors are active or incorrectly cabled	▶ Remove the obstacle ▶ Check the cabling between the Safety Sensor and the control unit, and eliminate any detected deficiencies ▶ Replace the Safety Sensor
Prior to commissioning: During manual opening, the Door panel encounters an resistance and closes at high speed		The motor connector plug is not correctly connected	▶ Plug the motor connector plug into the correct socket in accordance with application (pulling/pushing function).
Drive Unit fails to open	▶ LED SE (Safety Sensor, yellow) is not lighted ▶ LED OE (opening command, blue) reacts to the Activation Sensor ▶ Determine the Activation Sensor via the diagnostic level	Depending on the enabled operating mode, activation commands (inside/outside, etc) are ignored	▶ Switch on the main power switch on the Side Cover ▶ Measure the main supply voltage, check the cabling and eliminate any detected deficiencies ▶ Should the two above-mentioned measures not be successful, the Control Unit needs to be replaced
	▶ LED SE (Safety Sensor, yellow) is not lighted ▶ LED OE (opening command, blue) is not lighted despite the active Activation Sensor	The opening command is not evaluated	▶ Check the cabling between the Activation Sensor and the Control Unit and eliminate any detected deficiencies ▶ Replace the Activation Sensor

Erroneous Behavior	Analysis	Possible Causes	Remedy
Drive unit fails to close	LED SE (Safety Sensor, yellow) is lit	One or more Safety Sensors are active or incorrectly cabled	<ul style="list-style-type: none"> ▶ Remove the obstacle ▶ Check the cabling between the Safety Sensor and the control unit and eliminate any detected deficiencies ▶ Replace the Safety Sensor
	<ul style="list-style-type: none"> ▶ LED SE (Safety Sensor, yellow) is not lighted ▶ LED OE (opening command, blue) is lit 	An opening command is pending	<ul style="list-style-type: none"> ▶ Check the cabling between the opening element and the control unit and eliminate any detected deficiencies ▶ Replace the Activation Sensor
	Check the operating mode	The operating mode OPEN is active	Change the operating mode
The Operating Mode cannot be changed	Program selection keys on the side on the side cover are not lighted	The ribbon cable is not plugged in correctly, or not plugged in at all	Check the ribbon cable and eliminate any problems
	The Operating Mode symbol on the display is underlined	The Operating Mode is overridden via connection terminal X110	<ul style="list-style-type: none"> ▶ Change the operating mode by means of the external Power/ Mode Switch ▶ Correct the cabling of the external Power/Mode Switch

Notice: “If after troubleshooting a problem, and a satisfactory solution cannot be achieved, please call Nabco Entrances at 1-877-622-2694 between 8 am – 4:30 pm Central time for additional assistance. DO NOT leave any problem unresolved. If the door cannot be repaired immediately, turn off the door and leave it inoperable until repairs can be made. Advise the owner NOT to operate the door in the automatic mode until repairs are effected. NEVER leave a door operating without all safety detection systems operational.”

CHAPTER 11: SOFTWARE UPDATE VIA USB

A software update of the GT20 control unit can be quickly and easily achieved with a USB flash drive.

Note: Not all USB flash drives can be used. It is recommended to test your flash drive on a test bench GT20 before using it on a customer's product

Section 11a: Preparation

- ▶ The USB stick must contain a folder FD20G.
- ▶ The file name of the application will be similar to FD20GBL_V01_00_10.gds
- ▶ The name of the file extension must be **gds**.
 - The stick shall only contain one single FD20G folder.
 - There must be only one single file in the FD20G folder.

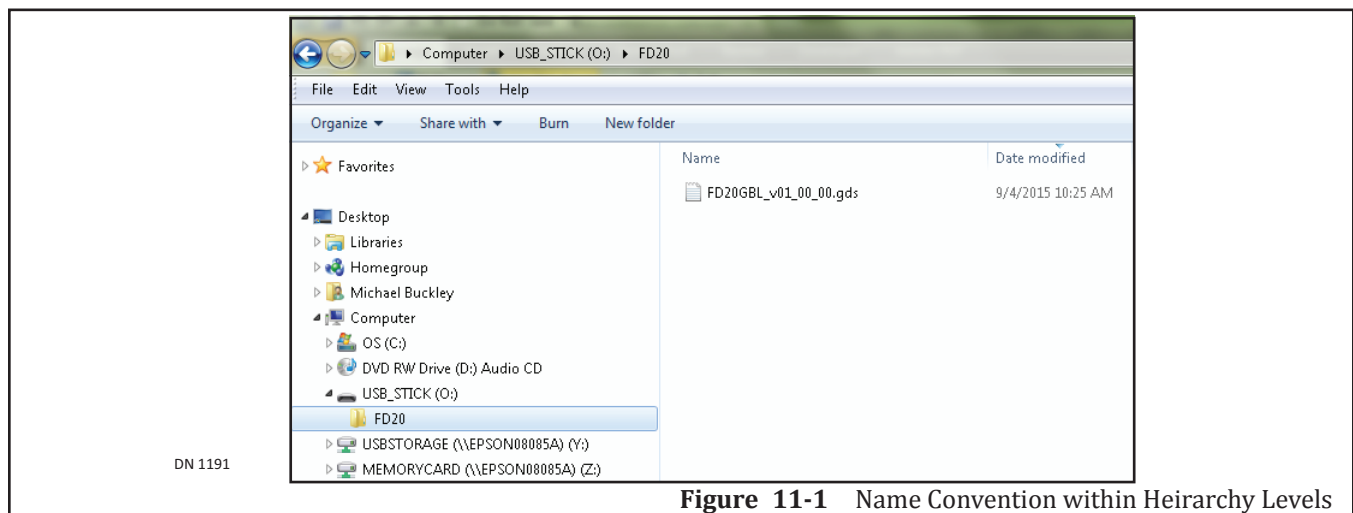

Figure 11-1 Name Convention within Hierarchy Levels

Section 11b: Procedure

1. Verify that the USB Stick has a folder in it named (FD20G).
 - a. The update will not work if the folder does not exist.
2. Open the folder named (FD20G). Verify that a single file with an extension of .gds exists.
 - a. The file should look similar to the following but the last two digits may be different: FD20GBL_V01_00_10.gds.
 - b. The V01_00_10 is the software version. This number can be used to compare the existing version installed on the GT20 Control.
3. Locate the USB port on the GT20 Control. Insert the USB Stick into it.
4. Turn the power ON.
5. Briefly push in on the Joystick until the Main menu is displayed.
6. Scroll until UPDATE SW is displayed.
7. Push in on the Joystick to select this item.
8. Select UPDATE LATEST.

9. Push the Joystick to the Left (3) times and Right (3) times to enter the password.
10. The LED display should black out and then a blue light should begin flashing. The new Software version will then display.

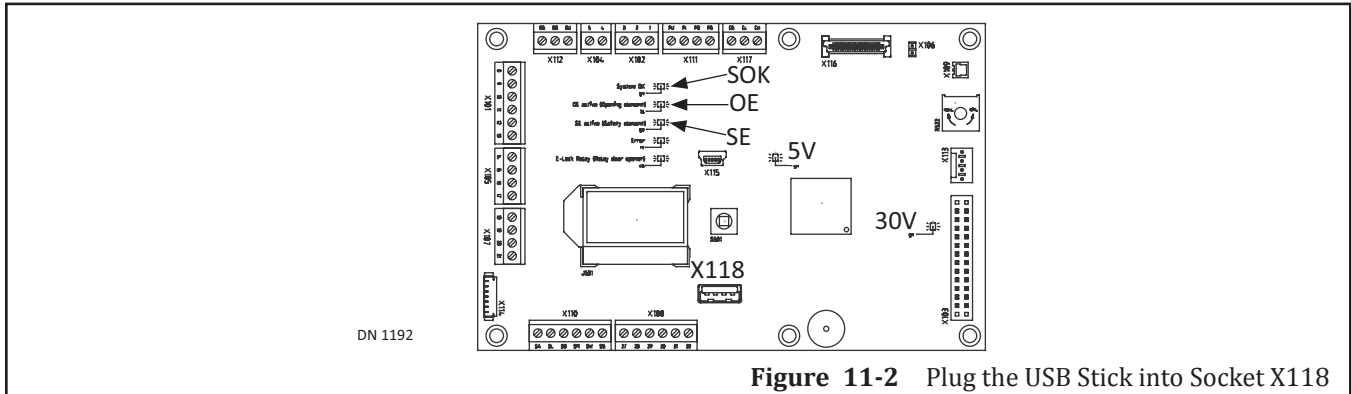

Figure 11-2 Plug the USB Stick into Socket X118

11.b.a: LCD display on the Control Unit

The display of the functions is ensured via three LEDs on the control PCB:

SOK	Green	USB-Loader started
OE	Blue	Activity in progress (delete/write memory)
SOK + OE	Green/Blue	Remove the stick after Download completed
SE	Yellow	Error

11.b.a: Possible Errors

- ▶ Incorrectly formatted USB Stick
 - This stick must be FAT or FAT 32 formatted (File Allocation Table from Microsoft).
- ▶ Several drives existing on the USB stick
 - Only one drive is legible.
- ▶ Invalid File
 - Not encrypted, damaged, FD20 missing in the file name, gds missing in the file extension.