

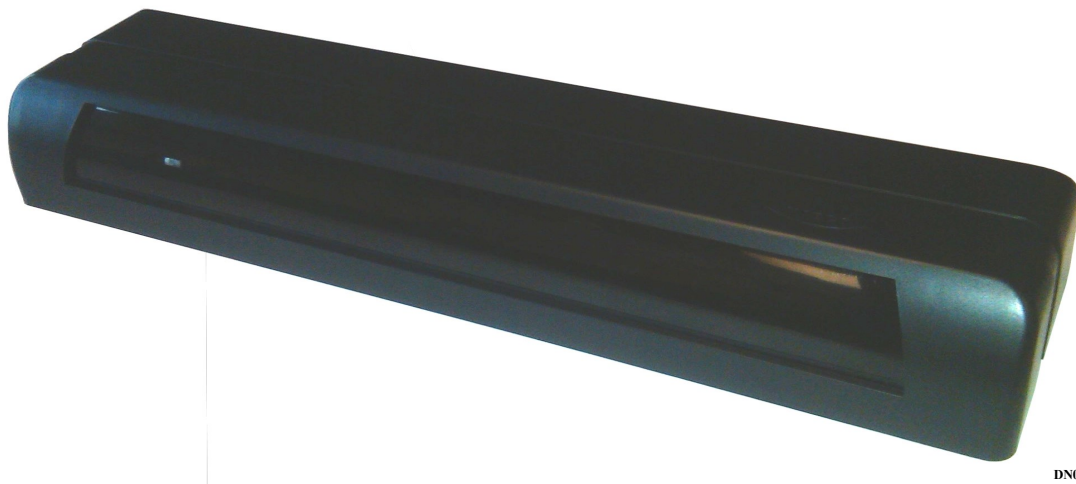

S82 W18717 Gemini Drive  
Muskego, WI 53150  
Phone: (877) 622-2694  
Fax: (888) 679-3319  
www.nabcoentrances.com  
Technical Assistance: 866-622-8325

# *Instruction Manual*

## *Acusensor 3*



### **NOT FOR USE AS A SWING DOOR SAFETY SENSOR**

This Sensor *does not* have adequate pattern detection for use as a safety presence detector on the Pull Side of Swing door.

#### **WARNING**

- Do Turn OFF all power to the Automatic Door if Safety System is not working.
- Instruct the Owner to keep all power turned OFF until corrective action can be achieved by a NABCO trained technician.  
Failure to follow these practices may result in serious consequences.
- NEVER leave a Door operating without all Safety detection systems operational.

P/N 15-8911-3  
January 16, 2015 Revision

Instruction Manual

CAUTION:

Do not install, operate or service this product unless you have read and understood the Safety Practices, Warnings, Installation and Operating Instructions contained in this manual. Failure to do so may result in property damage or bodily injury.

CAUTION:

The purpose of this manual is to familiarize the purchaser with the proper installation and operation of this system. It is essential that this equipment be properly installed and operational before the door is used by the public. It is your responsibility to inspect the operation of the entrance system to be sure it complies with any applicable standards. In the United States, ANSI Standard 156.10 and 156.19 usually cover the operation of the doors.

Instruct the building owners/operator on the essentials of the operation of the door and this device. The owner should follow these instructions to determine whether the

**NOT FOR USE AS A SWING DOOR SAFETY SENSOR**

This Sensor *does not* have adequate pattern detection for use as a safety presence detector on the Pull Side of Swing door.

## Contents

A. General Specifications	4
B. Appearance and Dimensions	5
C. Installation and Adjustment	
1. Installation	6
2. Wiring	6
3. Customized Settings	
a) Setting up depth coverage	7
b) Setting up width coverage	9
c) Setting up operation mode	
1) Setting up interference prevention modes	10
2) Sensitivity setting	11
3) Presence detection time	11
4. Turning ON the power	12
5. LED Indicator	13
6. Usage Tips	13
7. Trouble shooting	15

## A. Specifications

Part Description	Acusensor 3
Part Number	14-8902-3
Sensing System	Active reflective infrared system (Motion / Presence)
Power source	12 to 24V AC or DC Class 2
Recommended Temperature Range	-20 to +55°C (-4 to 131°F)
Power consumption	<2.5VA @24VAC, <100mA @12VDC)
Output Contacts Rating	Form A relay, 50V 0.1A Max. (Resistance load) No Detection: "OPEN", Detection: "CLOSED", Power failure: "OPEN"
Mounting height	6'6" (2m) to 9'10" (3m)
Detection area (when mounted at the height of 118")	Max. depth: 74.8" Max. width: 130.7" See page 10, figure 10 for more details
Output display	Green / Stand-by Red / 1st Row Detection Active Orange / 2nd Row Detection Active See page 13 for more details
Standstill memory time (learn time)	2 sec, 10 sec, 30sec, and 90sec
Output holding time	0.5 seconds
Weight	Approximately 1/2 lbs (8.5oz)
Color	Black

## B. Appearances and Dimensions

Figure 1 - Appearance

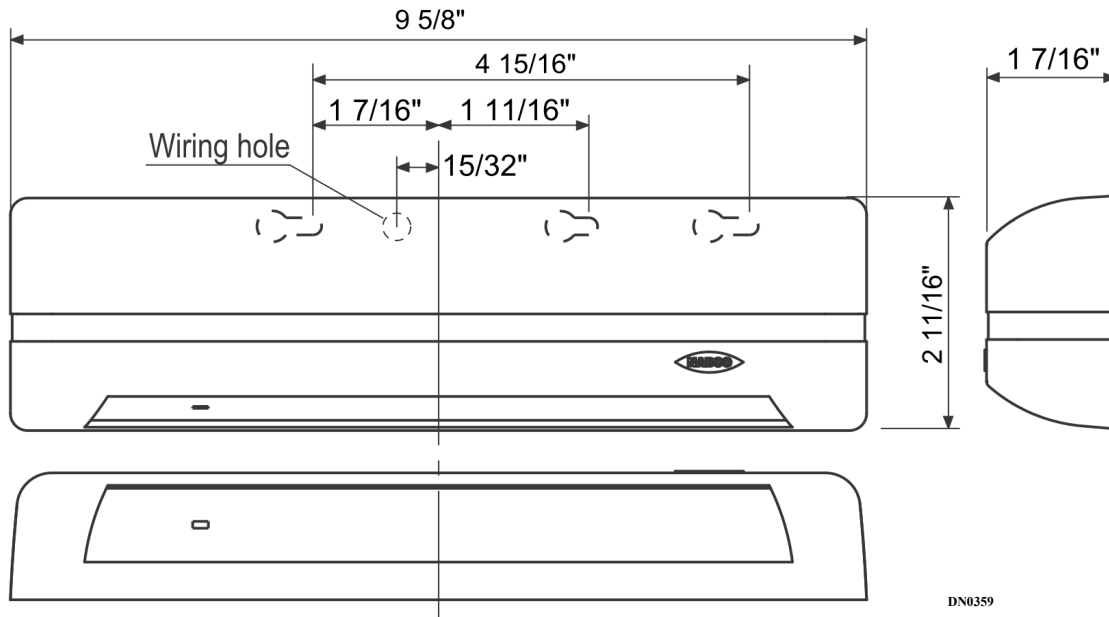
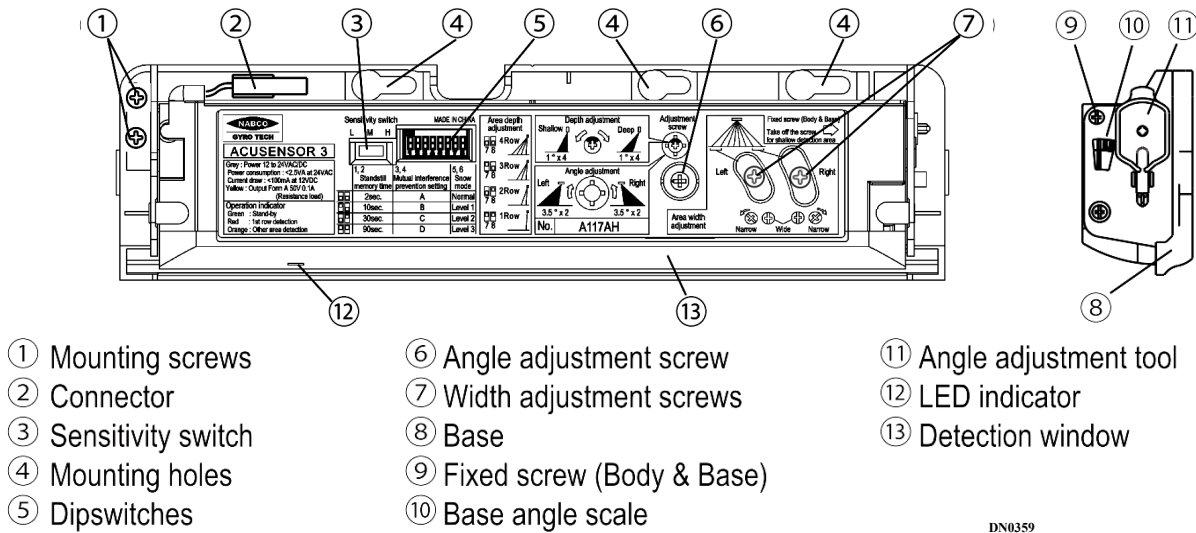

Figure 2 – Shown with cover removed



## C. Installation and Adjustments

### 1. Installation

Figure 3

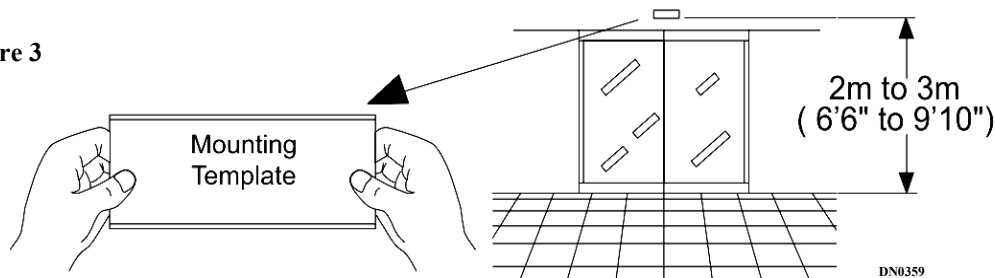

1. Affix the Mounting Template to the mounting surface (Figure 3).  
(When mounting on a header, do not locate the sensor higher than 4.5 inches above the bottom edge of the header as the header can block the detecting area.)
2. Drill two mounting holes ( $\varnothing$  3.4mm or 1/8").
3. Drill a wiring hole ( $\varnothing$  8mm or 5/16") for the sensor harness.
4. After drilling the holes, remove the Mounting Template

**CAUTION:** To prevent electrical shock, make sure that there are no electrical wires of other products in the area close to the place where you are going to drill.

Also, be sure that the mounting height is within the value of those in "SPECIFICATIONS" on page 4.

### 2. Wiring

1. Plug the Acusensor 3 Harness (P.N. 22-9184, Figure 4) into the 4 pin connector on the Acusensor 3.
2. Connect the Black and Red power wires to a class 2 transformer, or the Brown & Red 12 volt wires on a Microprocessor U series control, or other suitable power source.
3. Attach the White and Green wires to the activation or presence input of the door control.
4. Turn on the power and wait a minimum 10 seconds for the sensor to calibrate.

Note: There cannot be any motion within the sensing zone during this time.

Figure 4

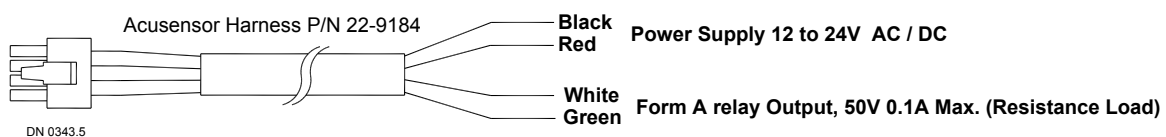

---

### 3. Customized Settings

The following information describes how to change the settings for depth of coverage, width of coverage, sensitivity and memory. Any changes to these settings that are made on site by the installer are the responsibility of the installer. Proper system operation must be verified according to ANSI Standard 156.10 and 156.19 or any local codes that apply to door operation.

#### a) Setting up for Depth Coverage

There are three ways to adjust the depth coverage: row settings (dip switches 7 and 8), base angle, and adjustment of the depth screw.

(See figures 5,6,7 on following page)

#### As an Activation Sensor

When the Acusensor 3 is intended to be used as a door activating device, the depth of coverage should comply with ANSI requirements.

When other sensors are being used for the activation function, it may be desirable (but not necessarily required) to reduce the sensing coverage area of the Acusensor 3. Adequate threshold coverage might be achieved by setting the various area settings. Coverage should always be checked to be sure it is adequate. For best detection of slow moving pedestrians or objects, the sensitivity option should be on Medium or High.

The width and depth of coverage for an actual installation may vary. This is typically the result of:

1. A variance in mounting height
2. Normal manufacturing and component tolerances
3. Variances in field measurements, procedures and conditions from ANSI standards.
4. Use of spacers for mounting

Figure 5

**Set the rows using dipswitches 7 and 8**

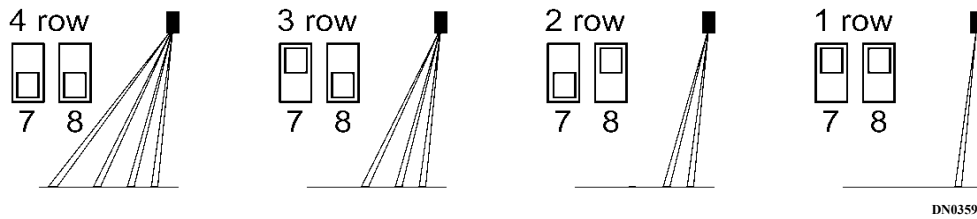

DN0359

**! CAUTION** Delayed activation can occur as rows are eliminated

Figure 6

**Setting the base angle**

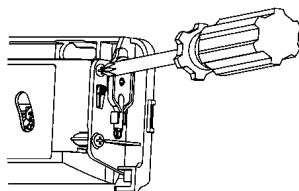

① Remove the Fixed screw (Body & Base)

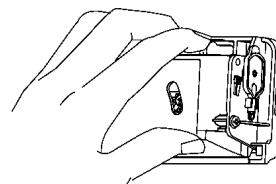

② Set the Base angle  
10° to 0° adjustable by 2.5° every one click

It's possible to confirm the angle by the scale.

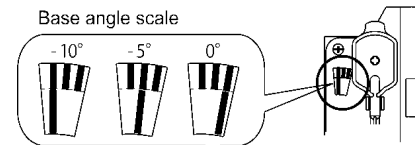

DN0359

Figure 7

**Setting the depth screw angle**

0° to 8° adjustable by 1° every one click as shown below

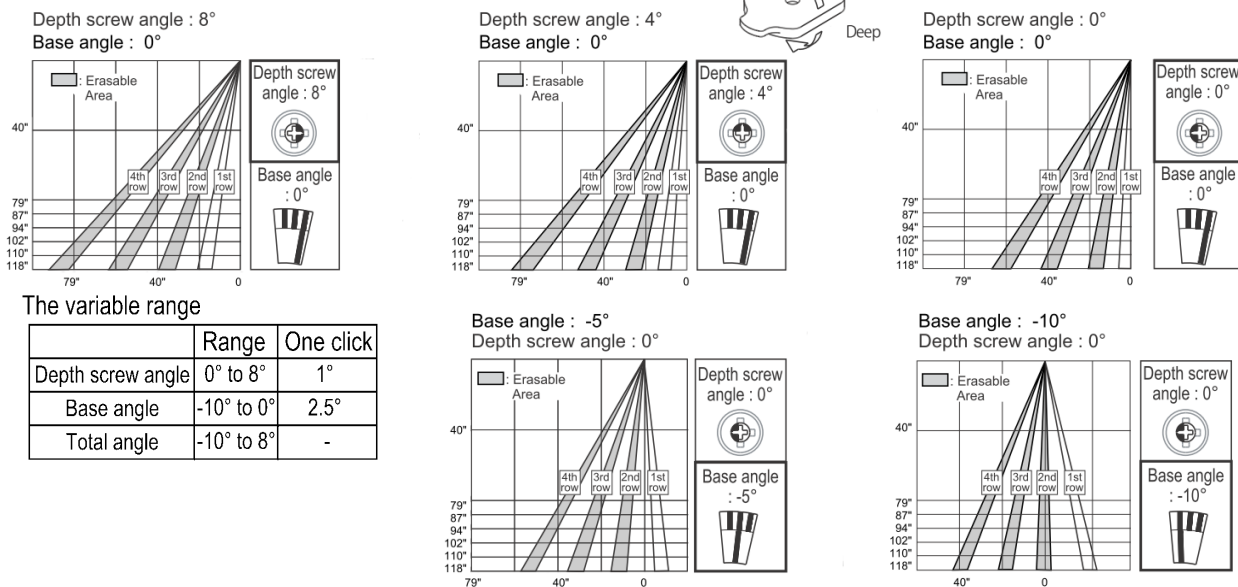

**! CAUTION** When detection area is tilted toward the door, the bottom edge of the header can block the sensor pattern if the sensor is installed too high on the header. DO NOT install sensor higher than 4.5 inches above the bottom edge of the header.



**b) Setting up for Width Coverage**

The area width can be adjusted by eliminating the outer areas of detection. (See figures 8,9)  
 The angle of the area can also be adjusted as shown below. (See figure 9)

**To adjust the pattern width**

Areas 1 and 2 can be eliminated and/or areas 7 and 8.  
 (1 and 2 cannot be separated, neither can 7 and 8)

Figure 8

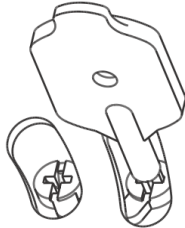

All areas on	Eliminate 1 2	Eliminate 7 8	Eliminate 1 2 7 8

See below for areas affected

DN0359

**To adjust the width angle**

Use the adjustment tool as shown below to change the width angle.  
 ±7° can be achieved in 3.5° steps each click ( Right / Left )

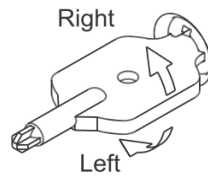
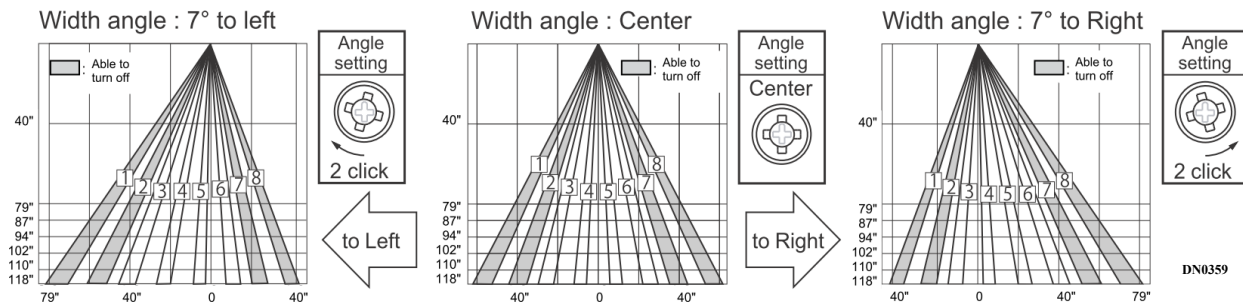
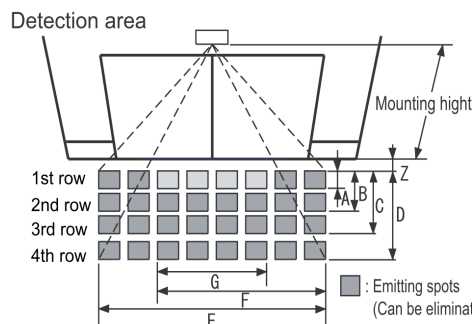

Figure 9



DN0359

Figure 10



**Coverage Chart**

Mounting Height	79"	87"	94"	102"	110"	118"
A	6.3"	6.7"	7.5"	7.9"	8.7"	9.4"
B	16.5"	18.1"	20"	21.7"	23.2"	25.2"
C	31.5"	34.6"	37.8"	40.9"	44.1"	47.6"
D	49.6"	54.7"	59.8"	64.6"	69.7"	74.8"
E	87"	95.7"	104.3"	113"	121.7"	130.7"
F	62.6"	68.9"	75.2"	81.5"	87.8"	94.1"
G	40.9"	44.9"	48.8"	53.1"	57.1"	61.4"
Z	1.6"	1.6"	1.8"	2"	2.2"	2.4"

Charts show the values in the following angle  
 Width angle : Center  
 Depth screw angle : 0°  
  
 Base angle : 0°

DN0359





**CAUTION** Risk of door collision  
 Setting the pattern for exact door opening may cause a slow response to side approaching traffic.

c) Operation Mode Set up

1) Mutual Interference Prevention Setting

Sensors placed close to each other should be set to different Interference Prevention Settings

Figure 11

frequency	A	B	C	D
Dipswitch				
	3 4	3 4	3 4	3 4

DN0359

When multiple Acusensor 3's are used in close proximity to each other, such as in a vestibule, the use of different modes will help prevent mutual interference. Using the mode switch, four modes are possible through a combination of positions on switches 3 and 4. Following is an example of one combination which might be used in a vestibule. (Figure 12)

Figure 12

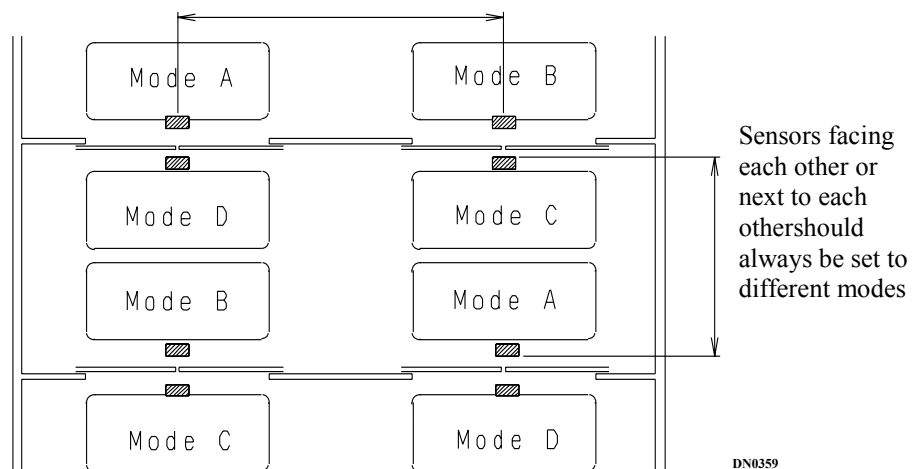

## 2) Sensitivity setting

Three sensitivities are available. High is the most sensitive setting. Low is the least sensitive setting. Under normal circumstances the medium setting should be used. When adequate detection cannot be achieved, use a higher sensitivity. If the Acusensor 3 activates unnecessarily, use the lower sensitivity. When low sensitivity is used, care must be taken to assure that adequate sensing is maintained.

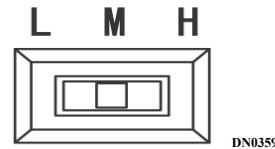





Figure 12

Normally set to "M"

There are also four levels of snow immunity that can be set using dip switches 5 and 6. Level 3 has the highest immunity (this may reduce sensitivity a small amount).

Figure 13





Snow mode	Normal	Level 1	Level 2	Level 3
Dipswitch	 5 6	 5 6	 5 6	 5 6

Note: Snow mode is only active when the temperature is at, or below 41°F (5°C)  
 If the sensor is installed during a warmer time of year, a second visit, when colder, may be necessary to check the detection pattern with snow mode activated.

## 3) Presence detection time

The Acusensor 3 computer will establish a base memory pattern of the total detection area when power is applied. Changes within the memorized detection area, whether on the floor or above the floor, will generate a signal to open the door. The base memory pattern will change automatically after the selected memory time set lapses if there is no movement within the detection area. The time interval at which these memory pattern changes will occur, can be adjusted using the dip switches 1 and 2.

Figure 14

Presence timer	2sec.	10sec.	30sec.	90sec.
Dipswitch	 1 2	 1 2	 1 2	 1 2

**CAUTION:** The Acusensor 3 emits active reflective infrared rays that detect the changing light intensity reflected from the floor surface in the detection area. The detection area is the reference area as determined by the Acusensor 3. Detection sensitivities can vary depending on the color of the object being detected. Care should be taken to ensure the sensor is adjusted to reliably detect colored objects consistently.

Detection areas will fluctuate as the sensitivity is adjusted.

**Be sure to confirm that the detection area is properly adjusted after any sensitivity adjustments are made.**

#### 4. Turning ON the power

- A. After installation and adjustments are completed, turn “ON” the power to the sensor, wait a minimum 10 seconds, then confirm the detection area.
- B. If the sensor does not detect or misdetects, confirm the detection area and mode setting and readjust if necessary.
- C. The doors could recycle or remain open indefinitely under the following conditions:
  - a. When adjusting the detection area or setting mode
  - b. When moving a mat within the detection area, such as when cleaning it.
  - c. When replacing a mat.
  - d. When moving things within the detection area or placing something new there.

- The Acusensor 3 starts to operate within seconds after the power is applied. However, at this point it is detecting motion only. For the final setup, keep out of the detection area. There must be no motion within the detection area for at least 10 seconds before presence detection can be established.

- 

#### **CAUTION**

**Please confirm that the wiring is correct before turning “ON” the power. Turn power “OFF” before making adjustments to the detection area or setting the mode setting switch**

## 5. Output Indicator

### A LED shows the following conditions.

Entry	Power off	Outside of detection area	Entry into 3rd or 4th row	Entry into 2nd row	Entry into 1st row	Outside of detection area
( Image )		 Stand-by	 Motion detection active	 Motion/Presence detection active	 Motion/Presence detection active	 Stand-by
Operation LED	None	Green	Orange		Red	Green
Output	Break		During detection or within presence time or relay hold time Make			When relay hold time is over after leaving detection area Break

**NOTE**

Sometimes detection can be difficult due to :  
enviromental light,  
colors of the object,  
and floor material /  
color.  
This might influence  
the speed of  
detection.

DN0359

## 6. Notice on usage

- A. The Acusensor 3 is designed to provide a detection area as close to the door as possible for maximum coverage. If the Acusensor 3 is installed on a non-vertical surface, the door may end up inside the detection area. When installing the Acusensor 3, adjust the detection area so that the Acusensor 3 does not detect the door.
- B. Be sure to unplug the sensor first before changing the detection or mode settings (If the settings are changed when the power is ON, the Acusensor 3 may malfunction.)
- C. Electric power consumption is 100mA (max) at 12VDC per Acusensor 3. Under low power conditions, the Acusensor 3 may malfunction. Be certain the power supply used is capable of supplying the necessary current required for all devices.

- D. If you install an Acusensor 3 in a place where rain falls and puddles form, or excessive auto mobile exhaust or insects accumulate, the Acusensor 3 may malfunction. To avoid this, lower the sensitivity.  
(See page 11 in this Instruction Manual.)

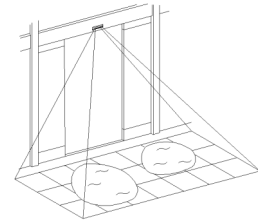

DN0359

- E. If you have a short split curtain, flowerpot or any other items that may shake in the detection area, the Acusensor 3 may false activate. Move the items out of the detection area.

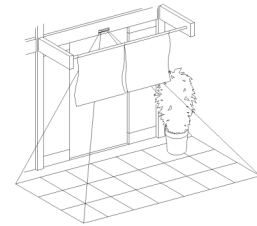

- F. If a door mat is used on the floor, a shop sign or a shopping basket is put in the detection area, do not set the standstill object detection time to “forever detection”. If the items in the detection area move a bit, the door may be held open.

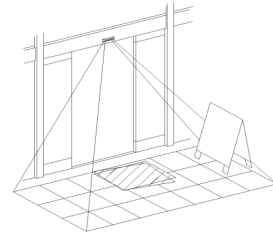

- G. If two or more Acusensor 3s are used close to one another, ghosting may occur due to mutual interference. Be sure that every Acusensor 3 has a different mutual interference mode. (See page 10 in this Instruction Manual.)

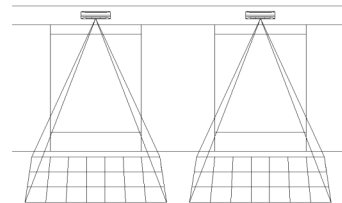

- H. Too much reflected light off the floor may reduce the sensitivity causing the Acusensor 3 to malfunction. Adjust depth and width area accordingly.

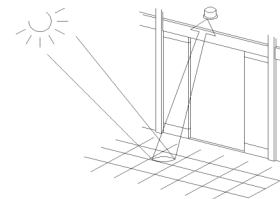

- I. If the Acusensor 3 is installed in a place where rain or snow falls on it, damage to the sensor may occur. In this case, use Acusensor 3 Rain Cover ( P/N 14-13783 ).

- J. If the background condition within the infrared detection area suddenly changes due to a strong snowstorm, the Acusensor 3 could ghost. In this circumstance, choose the Snow mode or lower the sensitivity. After the sensor is set to Snow mode, make sure the detection area is properly set. (See page 11 in this Instruction Manual.)

## 7. Troubleshooting

Condition	Possible cause	Solutions
Does not work	Failure of power/lead wire	Check the wiring and connectors
	Abnormal power source	Check to ensure the correct voltage is being supplied to the of Acusensor 3 (12~24VAC/DC.)
Does not detect	Sensor filter is dirty due to dust or water drops	Wipe the filter with a soft cloth with neutral detergent. (Do not use chemicals such as thinner or alcohol.)
	Low sensitivity	Adjust for higher sensitivity using the mode switch.
	Detection area inappropriate	Adjust the detection area by area setting switch, depth screw and base angle.
Misdetection	High sensitivity	Lower the sensitivity using the sensitivity switch.
	Overlap of detection area with other sensors.	Change interference prevention mode to be different from other Acusensor 3's. (When two Acusensor 3's interfere with each other, use mode A and mode B)
	Sensor detecting door	Confirm whether detection area is inclined toward the door. Adjust the detection area by depth screw or base angle.
	Moving object is within detection area such as a flag or a potted plant	Adjust detection area in order to avoid detecting the moving object or move the object out of the detection area.
	Detection area has changed	When the detection area changes from shopping carts being left in the doorway etc., the sensor will keep on detecting for the time set for presence detection time. Set presence detection time shorter using the dip switches. Note: Do not set presence detection time shorter than ANSI requirement.

**Questions?**

**Call Nabco Technical Assistance @ 1-866-622-8325**